



WWF

TECHNICAL
REPORT

ZA

2017

WWF NEDBANK
GREEN
TRUST



This publication is funded
by The Green Trust,
a partnership between
WWF and Nedbank.

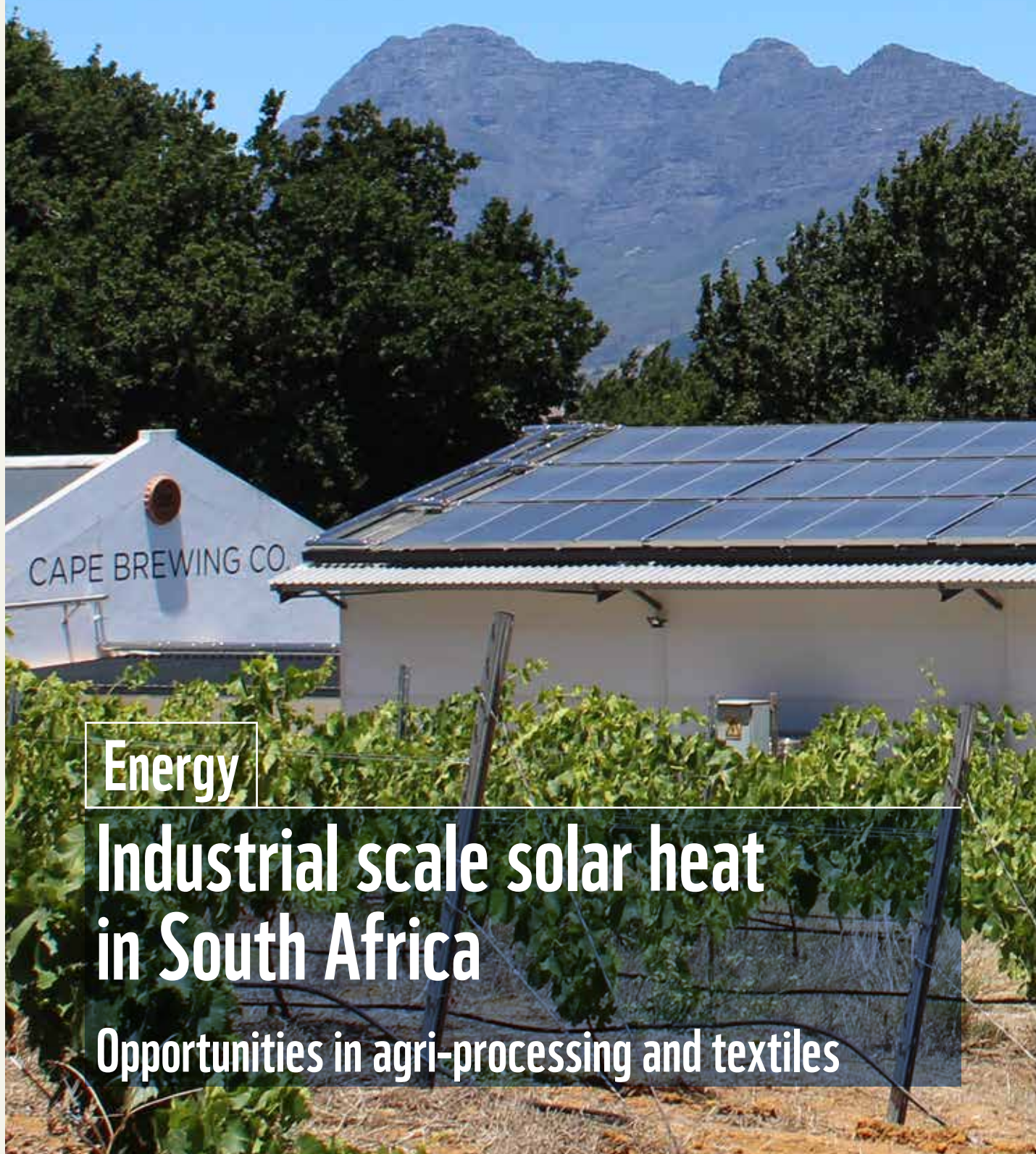

Energy

Industrial scale solar heat in South Africa

Opportunities in agri-processing and textiles

CONTENTS

Executive Summary	4	Key drivers of solar thermal in South Africa	43
List of Figures	7	Increasing energy prices	43
List of Tables	8	Cost comparison of thermal to existing thermal systems	44
Acronyms	9	Greenhouse gas emissions savings	47
Introduction	10	Energy efficiency incentives	47
South African solar potential	13	Cost-effectiveness of new build	48
How do solar thermal systems work?	15	Innovative contracting solutions	48
What is solar thermal	15	The Southern African Solar Thermal Training & Demonstration Initiative (SOLTRAIN)	49
How solar heat is captured: solar collectors	16	Key barriers to solar thermal	51
Moving the heat from collectors to industrial processes for different heat mediums	17	Knowledge and relative complexity	51
Water heating systems	17	Practical limitations	52
Air heating systems	18	High cost of solar thermal / infant industry in South Africa	52
Steam generation systems	18	Infant industry	54
Points for integration of solar heat into industrial applications	19	Requirement for systems testing for certification	56
Processes requiring heat	22	Funding availability	56
Matching process heat to solar technology	24	Conclusion	58
Solar thermal industry overview	26	Key conclusions for industries utilising heat	58
International market	26	Key conclusions for solar thermal industry	59
South African market	27	Key conclusions for policymakers	60
South African Solar heat for industrial processes (SHIP)	28	Appendices	63
Future Projections	29	International solar heat for industrial processes (SHIP) database	63
Potential for selected industries	31	Alternative presentation of heating integration concepts	65
Industry as energy user	31	South African Solar Thermal Technology Roadmap	66
Agri-processing	32	Agri-processing processes heat needs overview	67
Agri-processing: international case studies	33	Textile industrial sectors	69
Estimating agri-processing potential in South Africa	34		
GHG emissions savings from solar thermal in agri-processing	35		
Agri-processing case study: Cape Brewing Company (CBC)	36		
Textiles	37		
Textile industry: international case studies	38		
Size of the textile industry opportunity	38		
Textiles case study: ACA Threads	39		
Textiles case study: Migra Group	41		
Overall potential	42		

EXECUTIVE SUMMARY

South Africa has some of the highest levels of solar irradiation in the world, and while both domestic and industrial use of PV to generate electricity has gained traction, the use of solar

thermal for industrial process heat has not attracted much attention. The agri-processing and textile industries offer key market opportunities due to their need for low temperature heat (below 160 °C)¹.

Although the use of solar thermal technology in industry is highly applicable to low temperature requirements, the key reason why it has not received the level of attention of PV is due to the high cost of both the installation of the plant and the storage of heated water.

Also, at present, solar technologies are not well understood by most potential clients. This gap needs to be bridged through clear and transparent communication about the costs, benefits and practical implications of solar thermal technologies. Existing case studies, both internationally and locally, demonstrate the financial feasibility of solar thermal technologies over alternative systems (except possibly for coal-burning), with a pay-back of between 5 and 10 years depending on the replacement fuel. Going forward, the case for replacing oil-based fuels with solar thermal technologies is likely to improve as energy prices continue to rise, as it would for all fuels, should the proposed carbon tax be instituted.

The high capital cost of solar thermal technologies often presents as a barrier to uptake. However, this can be overcome through financing or the use of innovative contracting provided by Energy Service Companies (ESCOs). ESCOs are able to both reduce the risk of inefficient installations and lower or even remove the capital cost constraints of this relatively capital intensive intervention. ESCOs provide the capital costs involved in return for either a) a share in the energy savings with guaranteed savings, limiting risk or b) payment for the energy provided (at a lower cost than the original supply).

The potential for the use of solar thermal in the agri-processing and textile industries can be quantified in terms of the potential size of installations with estimates suggesting 425 000–3 758 000 m² for agri-processing and ~519 000 m² for the textiles industry, providing 425–3 758 GWh and 519 GWh of heat per annum, respectively². This is estimated to present a substantial decarbonisation potential of 110 922–942 556 tonnes CO₂e per annum saved in the agri-processing industry and 58 687 tonnes CO₂e per annum saved in the textiles industry.

¹ AEE Intec, 2009. *Thermal use of Solar Energy, Southern African Solar Thermal Training and Demonstration Initiative*. Stellenbosch, AEE Institute for Sustainable Technologies.

² The high variability is due to the different data sources considered. The higher estimate is based on the data source that includes coal used in industry. As the use of coal boilers is common practice, the upper estimate is likely to be more realistic.

There are existing policies in South Africa explicitly supporting the development of the agri-processing and textile industries as well as the solar thermal industry. The increased uptake of solar thermal technologies in agri-processing, which could lead to cost savings and energy security, is thus clearly aligned with government policy intentions. Evidence of the government's commitment to agri-processing is seen in the Agri-parks initiative, coordinated by the Department of Rural Development and Land Reform with the collaboration of several other government departments³. These have been established in over 45 districts throughout South Africa. The nine-point plan of the Agri-parks programme includes resolving the energy challenge and revitalising agriculture and the agro-processing value chain (RAAVC). Agri-parks present a unique opportunity to address the development and the sustainability of agri-processing simultaneously.

Small and medium enterprises can apply to SOLTRAIN for financial support.⁴ SOLTRAIN also provides information on demonstration systems to show what can be accomplished with solar thermal technologies.⁵ Both SOLTRAIN and GreenCape⁶ can provide contact information for designers and installers. In general, new installations would typically be more cost effective than retrofitting existing plants; hence new installations present a key opportunity for solar thermal uptake.

The market for large-scale solar thermal systems is currently relatively under-developed in South Africa. This combined with the relatively high and significantly varying costs of these systems could make it challenging for potential clients to make sense of quotes and to select an installer. There is a need for the industry to build experience and to draw on this experience to improve cost competitiveness. A range of industry support initiatives are available, including training for designers and installers offered by SOLTRAIN.⁷

As an 'infant industry' the solar thermal industry requires support to enable viable businesses that are able to grow and make a sizeable contribution to economic growth and job creation. The income tax rebates, such as 12L which have been implemented to promote energy efficiency, are however not available for the solar thermal industry. Solar thermal installations could, however qualify for the 12B tax incentive, allowing for accelerated depreciation of the capital cost for tax purposes.

Although there is a wide range of supporting programmes for solar thermal technologies,⁸ it is very important to ensure that the different programmes support and leverage off each other and avoid duplication, by encouraging and creating opportunities for communication, collaboration and complementarity.

³ An Agri-park is a networked innovation system of agro-production, processing, logistics, marketing, training and extension services, located in a District Municipality.

⁴ Southern African Solar Thermal Training & Demonstration Initiative. See: <http://soltrain.co.za/> for more information.

⁵ The capital costs of solar thermal installations can be subsidised up to 50% of costs when installing smaller systems at a company that would be willing to become a SOLTRAIN demonstration system. Contact Karin Kirtzinger for more information: karink@sun.ac.za.

⁶ Requests can be made to: energy@greencape.co.za.

⁷ SOLTRAIN has already provided 24 train the trainer and 39 dissemination courses in Phase 2 (2012–2016) with aim to train 500 persons in 22 training courses in the current Phase 3 (2016–2019) (SOLTRAIN, 2016).

⁸ For example: South African National Energy Development Institute (SANEDI), Southern Africa Solar Thermal and Electricity Association (SASTELA), Southern African Solar Thermal Training and Demonstration Initiative (SOLTRAIN), Centre for Renewable and Sustainable Energy Studies (CRSES), Sustainable Energy Society of Southern Africa (SESSA), Western Cape Energy Game Changer etc.

The solar thermal industry is envisaged to grow significantly in the coming years: the South African Solar Thermal Technology Roadmap (SA-STTRM) envisages exponential growth to 4 000 000 m² of large installations by 2030. This report highlights the potential within the agri-processing- and textile- sectors of 945 000–4 250 000 m² of industrial scale installations. It is the intent that the insights and recommendations in this report provide a motivation and a foundation for the uptake of industrial scale solar thermal systems to enable this potential to be realised, assisting South African industries to decarbonise while becoming more resilient.

List of Figures

Figure 1: Global horizontal irradiation on the earth	13
Figure 2: Global horizontal irradiation (GHI) for South Africa	14
Figure 3: Comparison of solar PV and solar thermal	15
Figure 4: Range of solar collectors	16
Figure 5: Solar heat in industrial process preheating with five subsections	18
Figure 6: Preheating of air for drying	18
Figure 7: Direct solar steam generation	19
Figure 8: Possible integration points for solar process heat	20
Figure 9: Classification of industrial heat consumers for the integration of solar heat for industrial applications	22
Figure 10: Stationary and tracking solar collector technologies related to operation temperature and process temperature range in different industrial branches	25
Figure 11: Global solar thermal capacity in operation and annual energy yields 2000–2014	26
Figure 12: Total water collectors in operation by the end of 2013 (MWth)	27
Figure 13: Potential Industrial, commercial and multi-family residential installations for solar heating and cooling as per the SA-STTRM vision	29
Figure 14: CBC brewery's 120 m ² flat plate collector array (SOLTRAIN, 2016)	37
Figure 15: ACA Thread's 156.4m ² evacuated tube array	40
Figure 16: A schematic of Migra's system	42
Figure 17: Electricity price index and consumer price index (2004 base year)	44
Figure 18: Internal rate of return (IRR) for a current large-scale system with a service life of 20 years replacing different conventional fuels	46
Figure 19: Payback periods of current large-scale solar thermal system when substituting conventional energy sources	46
Figure 20: Specific investment costs and levelised costs of solar thermal generated heat for large pumped domestic hot water systems	53
Figure 21: Learning curve for industry	54
Figure 22: Proposal comparisons and component breakdown from the CBC tender	55
Figure 23: Envisioned accumulated installations in m ² 2014–2030	66

List of Tables

Table 1: General efficiency finder linking processes in industrial sectors with the availability of solar integration guidelines	23
Table 2: Extract from database of large (>10m ²) solar thermal installations in South Africa, detailing installations for process heat application	28
Table 3: Industrial sectors and processes with the highest potential for solar heating	32
Table 4: Largest 11 solar thermal systems in food and beverages industry from SHIP database	34
Table 5: Potential for solar heat in agri-processing	35
Table 6: Potential GHG savings from solar heating in agri-processing	36
Table 7: Solar thermal systems in textile industry from SHIP database	38
Table 8: Potential for solar heat in textiles	39
Table 9: Potential GHG savings from solar heating in textile industry	39
Table A1: Solar heating in industrial processes projects internationally by industrial sector	63
Table A2: Summary of solar heat integration concepts	65
Table A3: Matrix of industrial process indicators, food and beverages industry efficiency Finder	67
Table A4: Matrix of Industrial Process Indicators, Textile Industry Efficiency Finder	69

Acronyms

AEE	Arbeitsgemeinschaft Erneuerbare Energie
AFD	Agence Française de Développement
CPI	Consumer Price Index
CRSES	Centre for Renewable and Sustainable Energy Studies at Stellenbosch University
CSP	Concentrated Solar Power
DAFF	Department of Agriculture, Forestry and Fisheries
DEDAT	Department of Economic Development and Tourism
DoE	Department of Energy
dti	Department of Trade and Industry
EFOM	Energy Flow Optimisation Model
ERC	Energy Research Centre at the University of Cape Town
ESCO	Energy Service Company
GHG	Greenhouse Gas
GW _{th}	Gigawatt thermal
IEA	International Energy Agency
IEE	Intelligent Energy Europe
kW _{th}	Kilowatt thermal
MW _{th}	Megawatt thermal
MARKAL	Market Allocation ⁹
NEES	National Energy Efficiency Strategy
NERSA	National Energy Regulator of South Africa
OFID	OPEC Fund for International Development
OPEC	Organisation of the Petroleum Exporting Countries
PJ	Petajoule
RAAPVC	Revitalising Agriculture and the Agri-processing value chain
SABS	South African Bureau of Standards
SANEDI	South African National Energy Development Institute
SASTELA	Southern Africa Solar Thermal and Electricity Association
SA-STTRM	South African Solar Thermal Technology Road Map
SATIM	South African TIMES model
SESSA	Sustainable Energy Society of Southern Africa
SHIP	Solar Heat for Industrial Processes
SOLTRAIN	Southern African Solar Thermal Training and Demonstration Initiative
STERG	Solar Thermal Energy Research Group
TIMES	The Integrated MARKAL-EFOM System
TJ	Terajoule

⁹ MARKAL = numerical model used to carry out economic analysis of different energy related systems at the country level.

INTRODUCTION

Despite having some of the highest levels of solar irradiation in the world, South Africa has relatively few solar thermal installations.

South Africa's 1 055 MW_{th} of installations are substantially less than Austria's 3 541 MW_{th} and Germany's 12 281 MW_{th} of installations.¹⁰ In addition, South Africa's solar thermal opportunity in industrial applications is significant as industry is one of the largest energy users in South Africa (36–46%),¹¹ and half of energy use in South Africa is for heat.¹² Furthermore, South Africa is highly reliant on fossil fuels for its energy needs. Solar energy thus provides a key opportunity to decrease this reliance and the attendant risks of price volatility, while also reducing greenhouse gas emissions.

While industry has already started using RE for meeting electricity needs, to date insufficient attention has been paid to the potential of RE in industrial applications. Where it has, adoption of RE for industrial processes has been limited to sectors such as the sugar and pulp and paper manufacturing sectors, where waste is used to generate heat. A range of commercially available renewable energy technologies (RETs) can meet the energy needs for process heat, and therefore support decarbonisation of industry.

The report focusses on the opportunity for solar thermal uptake in the agri-processing and textile industries. Solar thermal finds the best application where the heat requirement is below 160 °C. Both industries require a significant amount of low temperature heat, which solar thermal energy is able to provide most economically. In addition, both industries have been identified as key to economic development by the government in the Department of Trade and Industry's Industrial Policy Action Plan (IPAP). The choice of the agri-processing industry is also influenced by the fact that the agri-processing industry has been highlighted as a key industry for government support¹³ from the proposed Agri-park programme of the Department of Agriculture, Forestry and Fisheries (DAFF) and the Department of Rural Development and Land Reform (DRD&LR). This programme aims to establish

an agri-park as an agricultural business hub in each of South Africa's district municipalities.

The report is structured as follows: The next section provides an overview of South Africa's solar resources and is followed in section 3 by a discussion on what solar thermal energy is and how it works. The current market for solar thermal systems internationally and in South Africa is then considered in section 4. The fifth section presents estimates of the potential for solar thermal in the two industries identified as having potential, agri-processing and textiles, and includes both international and local case studies. Section 6 and 7 investigate some of the drivers increasing uptake of solar thermal in South Africa as well as the barriers. The final section of the report captures the key findings of the report as well as recommendations for the agri-processing, textiles and solar thermal industries as well for energy-, carbon- and industrial development policymakers.

The textile industry has also been identified as a key industry for government support¹⁴. The potential for solar energy in the textile industry is of particular interest due to the large share of processes requiring low temperature heat, especially for natural textiles.

10 Available at: www.iea-shc.org/data/sites/11/.../Solar-Heat-Worldwide-2015.pdf.

11 36% according to the Department of Energy (DoE) energy balance and 46% according to University of Cape Town (UCT) Energy Research Centre's (ERC) South African TIMES (SATIM) model.

12 Holm, D., 2015. Lessons Learned From SOLTRAIN, South Africa's One Million Solar Water Heaters Initiative and From International Champions – How to Improve Market Penetration in South Africa. In: J. Gibberd & D. Conradie, eds. *Smart and Sustainable Built Environments (SASBE) 2015 Conference Proceedings*, 9–11 December 2015. Pretoria: University of Pretoria, p. 443.

13 Through: a) Agri-Park programme of the Department of Agriculture, Forestry and Fisheries (DAFF) and the Department of Rural Development and Land Reform (DRD&LR) aiming to establish an Agri-park business hub in each district municipality. b) The Industrial Policy Action Plan (IPAP) of the Department of Trade and Industry (the dti) highlights the agri-processing as key industry to support due to its significant job creation potential.

14 Through the dti's Industrial Policy Action Plan (IPAP) due to its high labour absorption.



© STELLENBOSCH UNIVERSITY / CRSES

SOUTH AFRICAN SOLAR POTENTIAL

The potential for the application of solar technology varies across the world as some areas receive more sunlight than others. South Africa is fortunate to be one of the countries with some of the highest solar potential in the world.

This is shown in Figure 1 and Figure 2 which indicate the yearly horizontal irradiation for the earth and for South Africa, respectively. (Note that the colour scales differ between the two figures). Higher solar irradiation potential results in more energy produced by solar systems per unit area. Higher solar irradiation would thus be indicative of higher energy production and hence higher potential for solar energy technology uptake.

When considering the solar thermal systems installed internationally, South Africa has significantly fewer (1 055 MW_{th}) solar thermal installations than Austria (3 541 MW_{th}) and Germany (12 281 MW_{th}) (Mauthner, et al., 2015). However, these countries have significantly less solar potential, with both Austria and Germany having global horizontal irradiation (GHI) below 1 300 kWh/m², as shown by the colour differences in Figure 1. This suggests that South Africa has an abundance in solar resources that could provide a greater portion of the South African energy mix in the future.

Figure 1: Global horizontal irradiation on the earth

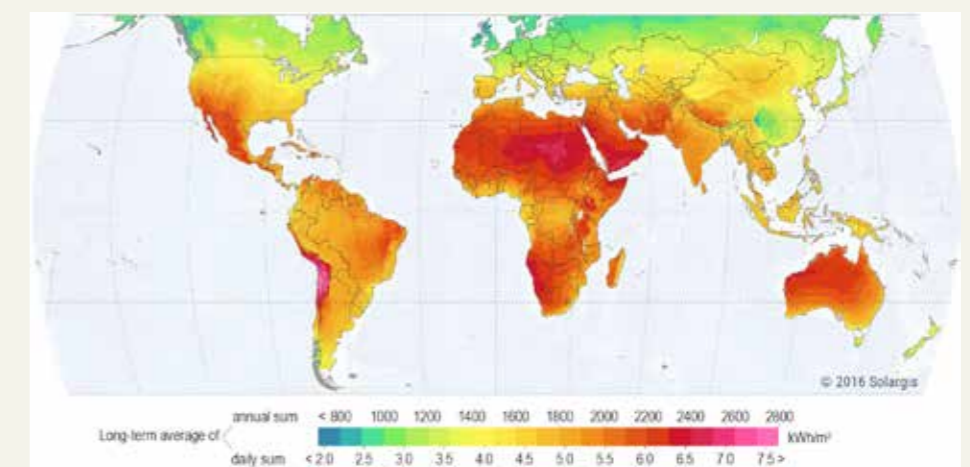

SOURCE: GHI SOLAR MAP © 2017 SOLARGIS

A solar thermal system feeds into a 10 000 litre storage tank at the Cape Brewing Company.

Figure 2: Global horizontal irradiation (GHI) for South Africa

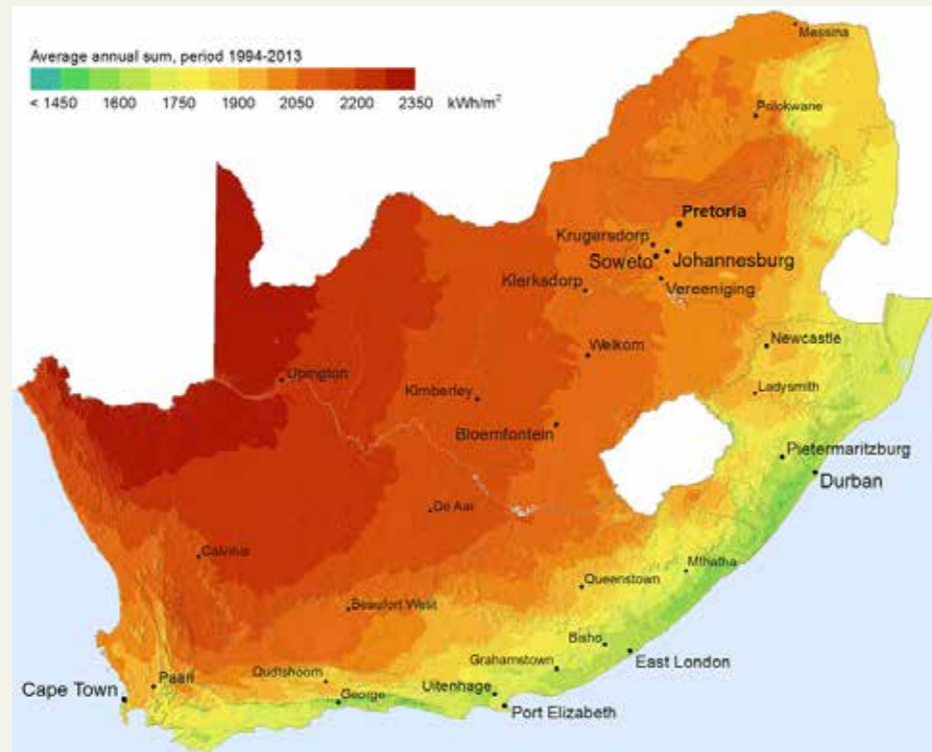

SOURCE: GHI SOLAR MAP © 2017 SOLARGIS

HOW DO SOLAR THERMAL SYSTEMS WORK?

What is solar thermal

The sun's radiation is the main source of most of the renewable energy resources on the planet. Radiation from the sun is experienced on the surface of the earth as light and heat. The light from the sun can be harnessed directly through photovoltaic (PV) modules. Heat from the sun can be harnessed directly through active heating using solar collectors to absorb the heat, and through passive heating to enhance the contribution of solar energy. This is illustrated in Figure 3.

Figure 3: Comparison of solar PV and solar thermal

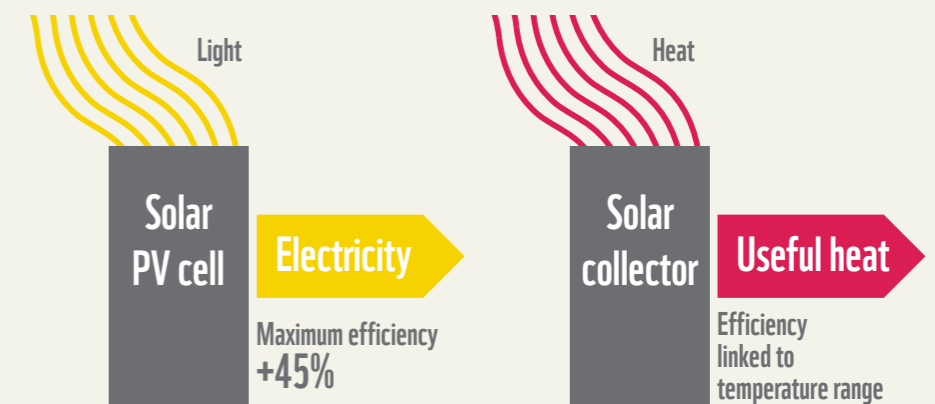

Solar thermal systems capture heat from the sun to heat a fluid or gas (e.g. water or air) to produce useful heat. While a wide range of temperatures is possible, the most economical application of solar thermal technology in industry is to low temperature applications (considered to be below 160°C).

Solar thermal systems typically complement existing systems to generate heat for processes. Their benefit lies in decreasing electricity or fuel costs and the associated greenhouse gas (GHG) emissions and thus decreasing the process' contribution to climate change. Solar thermal systems can typically be expected to achieve a solar fraction (the share of heat supplied by solar) of 60%–80% in South Africa (SOLTRAIN, 2016).

How solar heat is captured: solar collectors

The first, and often the most noticeable, component of a solar thermal system is the collector that is used to capture the heat. There is a wide range of solar collectors available, as illustrated in Figure 4 below. The efficiency of the collectors shown in the Figure 4 increases from left to right. The cost of materials and complexity of the systems generally increase with efficiency. However, the most cost-effective solution will vary from application to application. This range of solar systems presented is not exhaustive, but indicative of the most prevalent systems that are relevant to industrial scale applications of solar thermal systems.¹⁵

Figure 4: Range of solar collectors

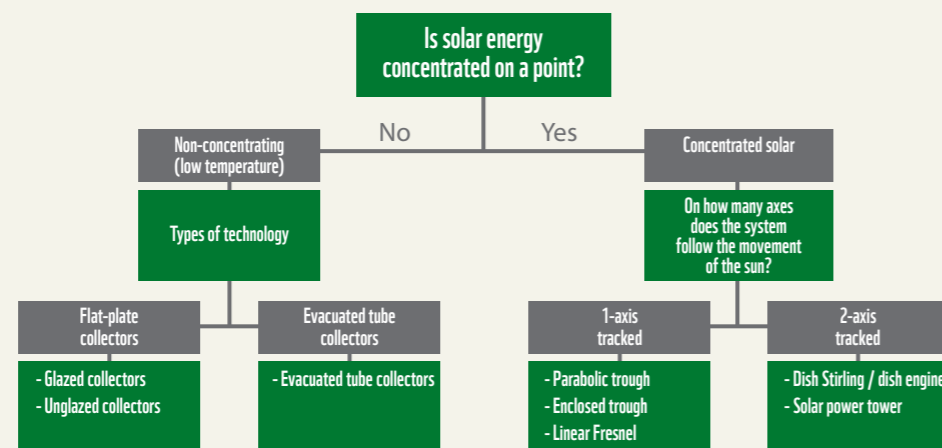

Most low temperature solar collectors are dependent on glass. Glass has the unique ability to let short-wave infrared radiation through and prevent long-wave infrared being re-radiated away from the collector. Heat can therefore be ‘captured’ in the collector. Another material, typically copper tubes or fins inside the collector, will absorb the radiation and transfer it to another medium, such as water. The amount of heat captured can be multiplied using reflectors, resulting in higher temperatures and increased radiation per area. This method for increasing the radiation level on a surface is referred to as concentrated solar technology. The use of concentrated solar technology is mostly limited to high temperature requirements, such as electricity production using large-scale concentrated solar thermal power plants.

¹⁵ For example, it excludes non-tracking concentrating solar energy systems (such as solar bowl and air heating systems), but it is indicative of the most prevalent systems.

Moving the heat from collectors to industrial processes for different heat mediums

Solar heat can be integrated into industrial processes using different heat mediums:¹⁶

- Heating of water¹⁷ (Figure 5)
- Heating of air (Figure 6)
- Steam generation (Figure 7)

Each of these will be briefly discussed in turn, describing the different mechanisms to take the heat from the collectors to the point in the processes where it is needed. In Figure 5, Figure 6 and Figure 7, the red line indicates the flow of the heated medium to the processes. As indicated, solar thermal systems typically complement existing systems to generate heat for processes. In all the systems there is thus a point of integration with existing heat sources.

Some systems do not contain all the subsections shown in Figure 5: these include preheating of air for drying¹⁸ and direct solar steam generation, which are shown in Figure 6 and Figure 7, respectively. Both of these have no storage.

Water heating systems

Figure 5 shows the different stages that are involved in a ‘typical’ solar heating system with heating through a liquid medium such as water.¹⁹ Starting from the left, the collector (any from Figure 4) heats the medium. The charge section utilises the heated medium to preheat the medium feeding into the collector using a heat exchanger (feeding in from the bottom to make use of thermal stratification). In the third stage, the heat is stored in a well-insulated storage container. The medium is then discharged (from close to the top to make use of the thermal stratification²⁰) to provide heat at the integration point through a heat exchanger that links to the conventional heating process (Q_{conv}). If the medium is sufficiently heated, the conventional heating may be switched off.

¹⁶ For a more complete overview see Helmke & Hess (2015) from which this section draws.

¹⁷ Including glycol solutions.

¹⁸ See www.cona.at and www.grammer-solar.com for examples of solar drying systems.

¹⁹ In Figure 9 this would be considered process level preheating with an external heat exchanger.

²⁰ Colder liquids are denser and warmer liquids are less dense thus the warmer medium would rise to the top of the storage container.

Figure 5: Solar heat in industrial process preheating with five subsections

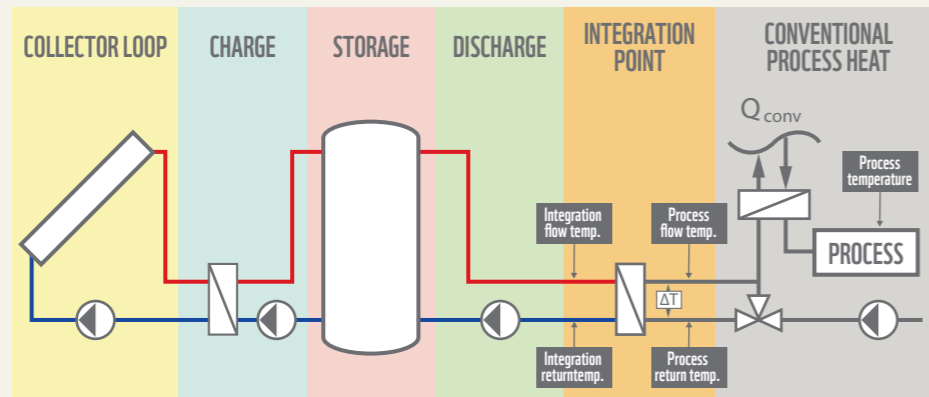

SOURCE: HELMKE & HESS (2015: 62)

Air heating systems

The preheating of air for drying involves heating air to help aid evaporation of moisture in products, as shown in Figure 6. The system collects heat and the heated air is then directed with a fan to the product that needs to be dried. The heat exchanger at the integration point also includes a conventional heating source (Q_{conv}), as with all the other systems.

Figure 6: Preheating of air for drying

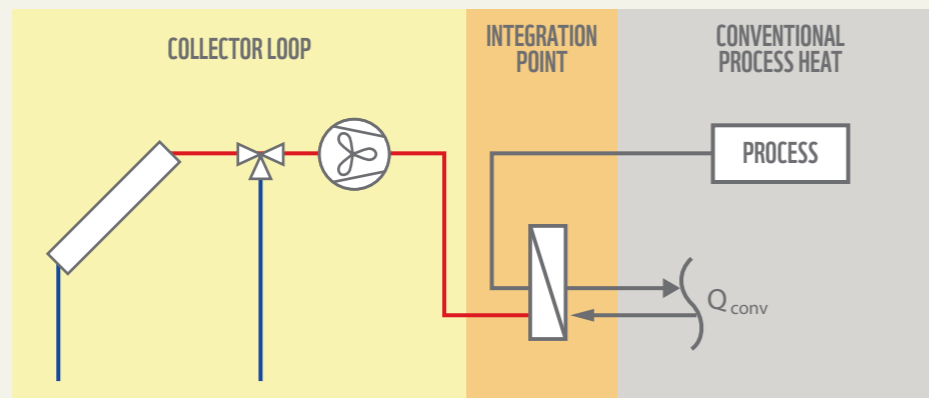

SOURCE: HELMKE & HESS (2015: 73)

Steam generation systems

Figure 7 shows how solar can be utilised for steam generation. Given the higher temperature requirements of steam systems, a concentrated solar collector is usually used (hence the different collector diagram). The medium is heated until it evaporates and then collected in a steam drum until there is enough pressure in the drum at which stage the valve at the integration point allows steam through until

the pressure drops. Any condensation that occurs in the drum is then fed back to the feed water to preheat the medium before entering the collector. Steam storage is not common due to high cost and thus excluded from consideration here. This system works most efficiently when a small share of the energy is provided by solar energy (i.e. at low solar fraction). It is important to note that the application of direct steam generation is rare. Most concentrated systems use a different medium with a high boiling point, such as oil or salt, to run through a heat exchanger, which in turn generates steam. Installations that generate steam in this manner are mostly power plants.

Figure 7: Direct solar steam generation

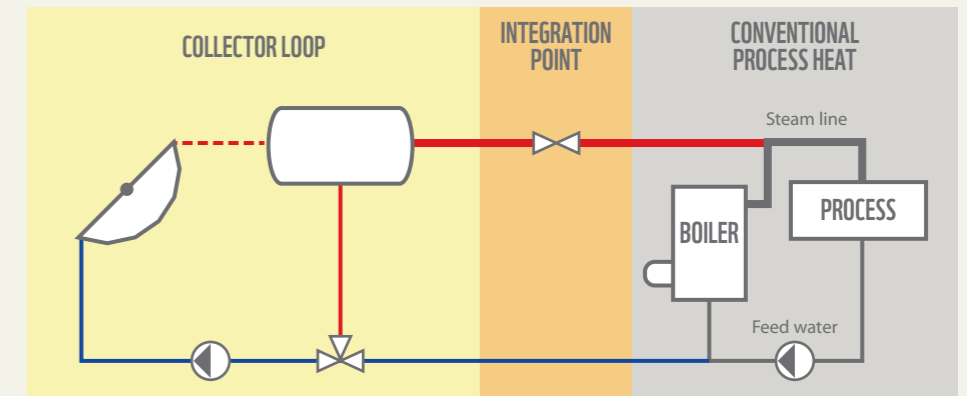

SOURCE: HELMKE & HESS (2015: 74)

Points for integration of solar heat into industrial applications

Industry requires energy for a wide variety of activities with a corresponding wide array of solar heat integration points. At the most fundamental level, heat can be provided for industrial systems at either the supply (A) or process (B) level as shown in Figure 8 for a generic industrial process. Both of these have a number of possible integration points which are shown in the same diagram. The different integration options at the supply level are:

- A1 – heating make-up water
- A2 – heating supply heat storage
- A3 – heating a heat supply network.

Alternatively, when integrating the heat at the process level it could be integrated by:

- B1 – heating the process or its vessel directly
- B2 – heating the process medium
- B3 – heating the process heat storage

Figure 8: Possible integration points for solar process heat

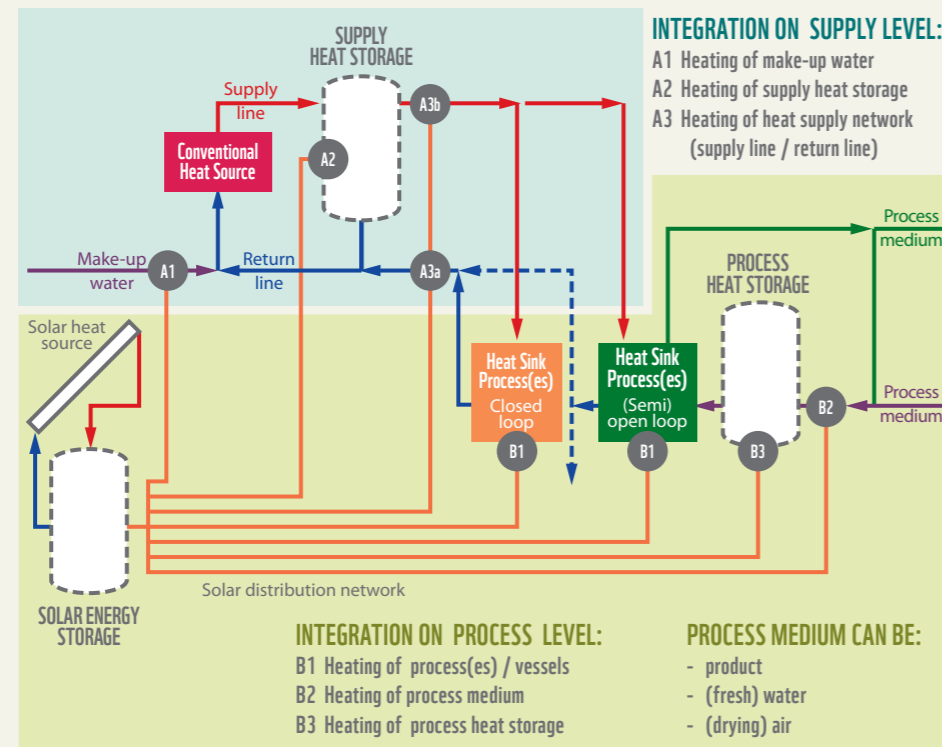

SOURCE: AEE INTEC (HASSINE, ET AL., 2015: 9)

The range of solar heat integration opportunities can be broken down further in two ways. Firstly, at the supply side, the medium that is heated: steam, liquid or air as mentioned earlier²¹. Secondly, at the process level, it can be divided in terms of whether a process is provided with heat, preheating or heat is used to separate substances. The most appropriate integration techniques linked to these integration points are shown in Figure 9 (with an alternative layout in Table A2 in the appendix).

This wide range of systems and integration methods and points may appear overwhelming, especially when the fact that different processes have different heating requirements is considered. However, to help overcome this complexity and learn how others have solved these problems in the past, there is an online database called the “Matrix of Industrial Process Indicators”²² that provides information at specific level (or unit of operation) for a range of processes. The database is designed as a decision support tool for experts in the field. The database includes best practice case studies linked to the specific processes in industries. The significance of the food and beverages industry as an opportunity for solar thermal systems is made more apparent in the Intelligent Energy Europe (IEE) GreenFoods project, which supplemented the food section of the database significantly as part of a broader project to enhance greater renewable energy use in the European food and beverage industry.

21 In principle the integration concepts for liquid heat transfer media are also valid for air as heat transfer medium (GreenFoods, 2014).
 22 Accessible online at: <http://wiki.zero-emissions.at>.



In solar water-heating systems, the heated medium is used to preheat the medium feeding into the collector using a heat exchanger. The heat is then stored in a well-insulated storage container.

As solar thermal systems are most economic at low temperature ranges, best practice suggests conducting energy efficiency solutions before installing solar thermal systems. This is due to low temperature energy sources (such as solar thermal) potentially competing with strategies for heat integration (e.g. cooling a hot stream by preheating a cold stream). In addition, as heat distribution systems are optimised for specific temperature ranges, conducting energy efficiency first helps to ensure the system works at a higher efficiency for longer, as energy efficiency interventions could possibly change the temperature levels of streams entering processes.

Figure 9: Classification of industrial heat consumers for the integration of solar heat for industrial applications

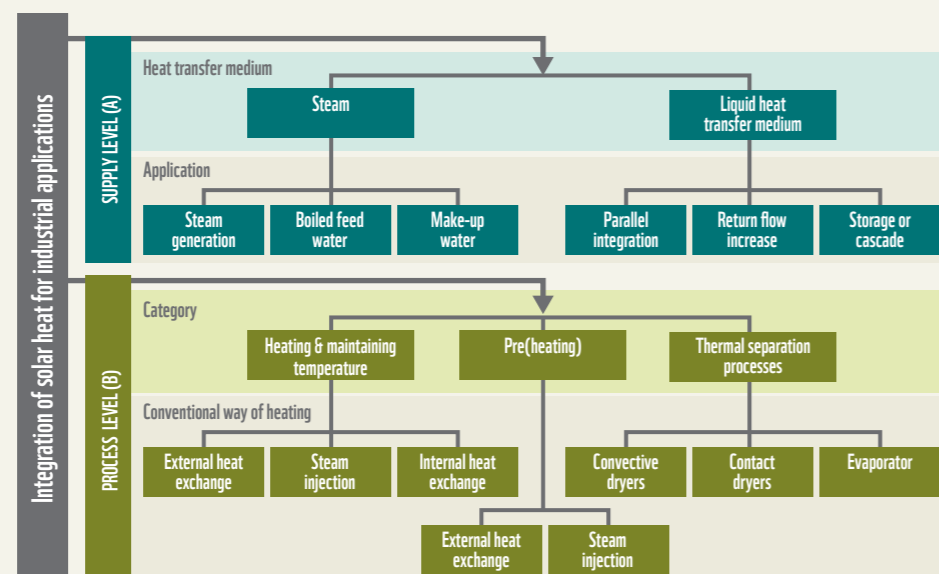

SOURCE: ADAPTED FROM GREENFOODS EFFICIENCY FINDER (GREENFOODS, 2014)

Processes requiring heat

As indicated, the “Matrix of Industrial Process Indicators”²³ aims to provide decision support for energy efficiency and renewable energy uptake with the database aiming to develop an interactive community to help exchange information. This decision support information was developed by a range of institutions with inputs from a wide range of industries.²⁴

23 Accessible online at: <http://wiki.zero-emissions.at>.

24 Three projects provided a significant amount of information. These projects are: GreenFoods (that ended in 2012), EnPro (set to continue to 2017) and Solar Automotive (set to continue to 2018).

Table 1: General efficiency finder linking processes in industrial sectors with the availability of solar integration guidelines

Unit of operation	Technologies		Industry sectors						
	Solar integration	Heat pump integration	Automotive	Chemicals	Food	Leather	Metals	Paper	Textiles
Cleaning	✓	✓*	✓	✓	✓	✓	✓	✓	✓
Founding	✓*	✓*	✓	✓			✓		
Pressing	✓*	✓*	✓				✓	✓	
Drying	✓	✓*	✓		✓	✓	✓	✓	✓
Evaporation & distillation	✓	✓*			✓				
Blanching	✓	✓*			✓				
Pasteurisation	✓	✓*			✓				
Sterilisation	✓	✓*			✓				
Cooking	✓	✓*			✓				✓
Other process heating	✓*	✓*	✓	✓	✓		✓	✓	✓
General process heating	✓	✓*			✓				
Heating of production halls	✓	✓*			✓				
Cooling of production halls		✓*			✓				
Cooling processes		✓*	✓	✓	✓		✓		
Melting	✓*	✓*			✓				
Extraction				✓	✓				
Sizing								✓	
Bleaching			✓		✓	✓			✓
Painting			✓			✓		✓	✓
Surface treatment	✓		✓			✓	✓		

* Currently shown but not linked to specific page i.e. website not populated at time of extraction

SOURCE: MATRIX OF INDUSTRIAL PROCESS INDICATORS (AAE INTEC)

At the most aggregate level, there is an energy efficiency matrix, shown in Table 1 which provides an overview of the different types of processes within industries, as well as the availability of energy efficiency and solar integration guidelines for these processes. The matrix (Table 1) shows significant potential for solar integration in the food industry and to a lesser extent the textiles industry. The matrix also shows that there are other processes that can benefit from the integration of solar thermal energy than those evident in the selected industries showing, that the opportunity for solar thermal uptake is not limited to the industries highlighted in this document (corresponding to the grey shaded columns in Table 1)²⁵.

In addition to the General Efficiency Finder (Table 1), the database includes matrices for specific industries, including the agri-processing (included in the appendix as Table A3) and textile industries (included in the appendix as Table A4). These tables provide a more detailed breakdown into key industrial sub-sectors (e.g. milk, fruit, wine, meat etc. for the food industry; and cotton, wool etc. for the textile industry) and the specific processes related to these industrial sub-sectors. These more detailed matrices also indicate a more detailed breakdown of where solar integration is technically feasible. These reinforce the potential for solar thermal in the agri-processing (food and beverages) and textile industries as most processes in each industrial sub-sector have solar integration guidelines with most being in the low temperature range where solar thermal is most economical. While this paper focuses on the solar thermal opportunity, it is worth noting, as indicated before, that best practice for solar thermal systems is to undertake energy efficiency first to ensure the installation remains viable over its lifetime (SOLTRAIN, 2016). Finally, it should be emphasised that, while these generic guidelines are valuable for the identification of potential opportunities, technical and financial feasibility will be case specific and that new installations will require site-specific feasibility studies.

Matching process heat to solar technology

As different solar thermal systems (Figure 4) provide different temperature ranges, these can be matched to the temperature levels of different processes (Table 1, Table A3 and Table A4). This is done in Figure 10 showing different industrial sectors (and their related processes) together with the solar technology (collectors) that are applicable at different temperature ranges.

²⁵ Table 1 also shows the potential for use of heat pumps in various industrial sectors and processes. Heat pumps are devices designed to move energy opposite to the direction of spontaneous heat flow, in other words they move energy from a cold space to a warmer one. Heat pumps could thus provide heat on their own or in conjunction with solar thermal systems.

Figure 10: Stationary and tracking solar collector technologies related to operation temperature and process temperature range in different industrial branches

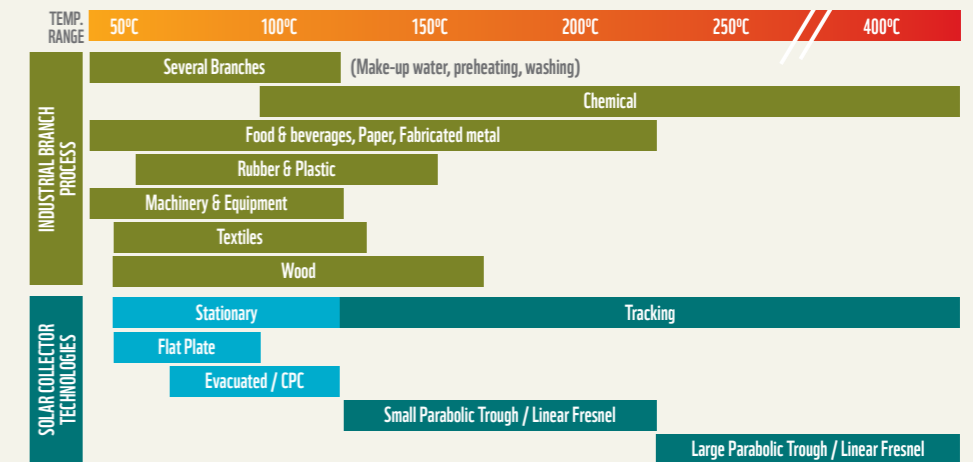

SOURCE: ADAPTED FROM HORTA, 2015

Figure 10 shows that both the industrial sectors identified in the report, textiles and agri-processing (or food and beverages) have relatively low temperature requirements that allow collectors with a relatively low efficiency (flat plate or evacuated tube collectors) to supply the required energy needs. As these technologies are non-tracking and do not having moving parts, they have lower maintenance costs. They are also non-concentrating, which generally translates into a simpler design and installation resulting in decreased installation costs. It follows that the most economic installations would be for low temperature applications or preheating for higher temperature processes (AEE Intec, 2009). The diagram also shows scope for application of small tracking systems, although this will be at a higher cost than the non-tracking solutions. It is also key to remember that higher temperature processes can still benefit from low cost (fuel-free) preheating.

SOLAR THERMAL INDUSTRY OVERVIEW

Having considered what solar thermal systems are and how they work, it is worth considering the current state of the solar thermal development both at an international and South African level.

International market

The solar thermal industry has been in development over many years. The Solar Heating and Cooling Programme was established in 1977 by the International Energy Agency (IEA). This programme also identified the use of solar heat for industrial processes as a specific research area (Task 49: Solar Heat Integration in Industrial Processes, which started in 2012). The global solar thermal market grew significantly in recent years, with a more than six-fold increase in the last 15 years, from 62 GW_{th} in 2000 to 406 GW_{th} in 2014 as shown in Figure 11.

Figure 11: Global solar thermal capacity in operation and annual energy yields 2000–2014

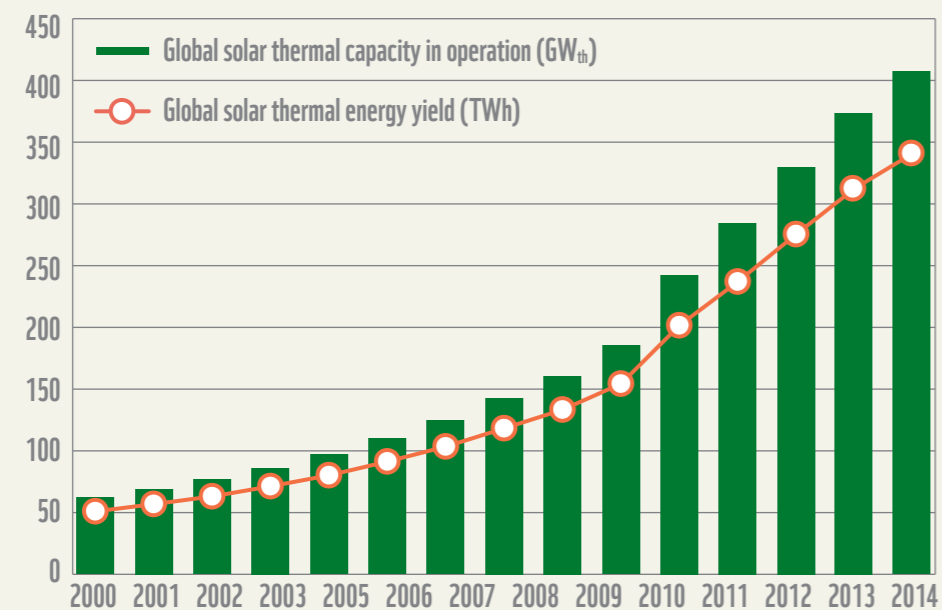

SOURCE: MAUTHNER, ET AL., (2015: 7)

While this growth is starting to slow in some areas, the Sub-Saharan region is the second fastest growing region in 2012/13, with market growth of 19%. Only the Middle East and North Africa (MENA) region²⁶ grew faster (at 27 %) over the same period (Mauthner, et al., 2016, p. 19).

South African market

The composition of the solar heating market by installation type for South Africa is contrasted with the composition of the market for the entire world in Figure 12. The South African market differs markedly from the world market, with 61% of all installations being unglazed, in contrast to 7% for the world as a whole (Mauthner, et al., 2015). The significant share of unglazed collectors could be indicative of the great solar irradiance of South Africa and the general application of solar heating systems for low temperature applications. This would result in less-efficient (unglazed) solar thermal systems (refer to Figure 4) being efficient enough to supply the required heat. The world share of evacuated tube collectors (ETC) is also skewed by China's large share of ETC (90%) due to a specific policy aimed to develop ETC. As China hosts nearly 70% of solar thermal systems, this results in a skewed distribution.

Figure 12: Total water collectors in operation by the end of 2013 (MW_{th})

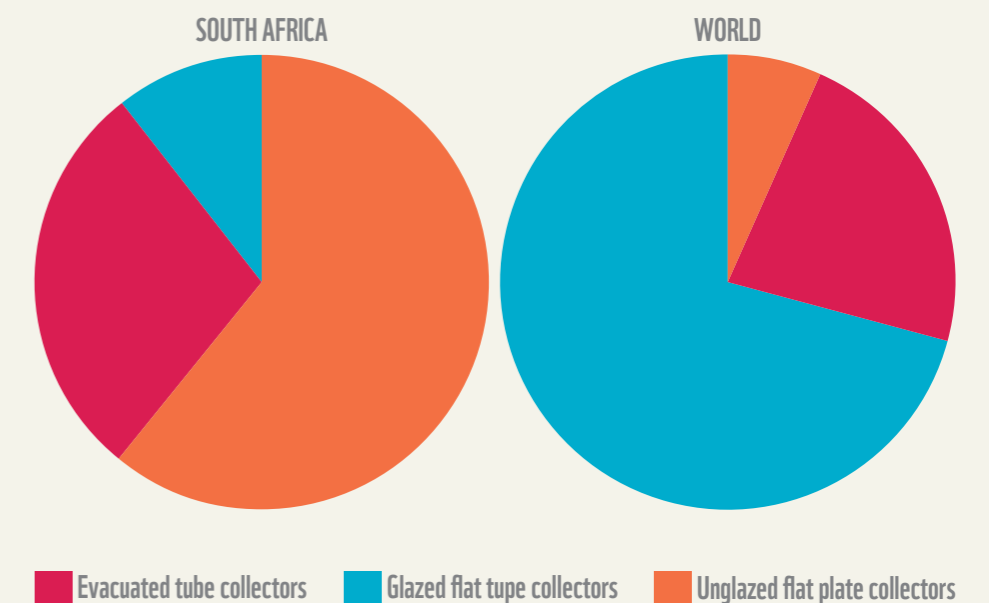

SOURCE: AUTHOR'S OWN CALCULATIONS²⁷

²⁶ Israel, Jordan, Lebanon, Morocco, the Palestinian Territories and Tunisia.

²⁷ Calculation using *Solar Heat Worldwide 2013* excluding air collectors as none in South Africa and only 0.3% of world installations in MW_{th} and thus visibly almost identical (Mauthner, et al., 2015). However, air collectors remain relevant for drying applications within agri-processing.

South African Solar heat for industrial processes (SHIP)

There are at least 89 large (> 10m²) solar thermal systems in South Africa according to the most comprehensive source available (Joubert, et al., 2016). Based on this database, the majority of systems (based on installation area in m²) are for domestic hot water use (including hospitals) (69%) and staff ablutions (20%). There are some applications to process heat (7%) and cooling²⁸ (4%).

The database includes seven industrial-scale installations that utilise solar energy for process heat. The basic information on these installations²⁹ is presented in Table 2. These practical examples show that solar thermal energy for industrial scale heating is a viable opportunity for real uptake in the South African context. The potential of agri-processing for solar thermal application is clear, with three of the seven (43%) installations within agri-processing, and one (14%) within the textile industry.

There are at least five known installers for industrial-scale solar thermal systems nationally (with more installers currently being added to the database). This shows that the ability to provide solar thermal systems for process heat is not monopolised by a specific company and is indicative of healthy competition in the industry.³⁰

Table 2: Extract from database of large (>10m²) solar thermal installations in South Africa, detailing installations for process heat application

Installer	Beneficiary/Client	Beneficiary Industry	City/Town	Collector	Year	Gross Area [m ²]	Storage Volume [litre]
HBC	BMW Manufacturing Plant	Automobile	Rossllyn, Pretoria	Evacuated tube	2012	200	24 200
RENU Holdings	Tanker Services, Imperial Logistics	Logistics	Durban	Evacuated tube	2013	67.5	5 000
E3	Cape Brewing Company	Food & Beverage	Paarl	Flat-plate	2015	120.6	10 000
Solarzone	Floraland	Horticulture	Bredasdorp	Flat-plate	2012	288	20 000
1Energy	ACA Threads	Textiles	Cape Town	Evacuated tube	2013	100	22 000
1Energy	Fairview Cheese Factory	Food & Beverage	Paarl	Evacuated tube	2012	90	4 000
1Energy	Quality Filtration System	Water Treatment	Somerset West	Evacuated tube	2012	75	2 000

28 Although heating is the focus of this paper, solar cooling may also be of particular interest for the food and beverages industry, as a significant amount of energy goes into cold-chain management within the industry.

29 Obtained from the authors.

30 A further contributing factor may be that SOLTRAIN has been able to provide training support for the industry to enable different companies to develop the necessary knowledge to work in this space.

Future Projections

A vision has been developed for large solar thermal systems as part of the South African Solar Thermal Technology Road Map (SA-STTRM). The component of this pertaining to large scale systems for industry is shown in Figure 13.³¹ It is clear that while there are currently very few large solar thermal systems, the SA-SSTRM envisions exponential growth in this market from just over 10 000 m² to just under 4 000 000 m² in 2030, an almost 40 000 % increase over 15 years.

Figure 13: Potential Industrial, commercial and multifamily residential installations for solar heating and cooling as per the SA-STTRM vision

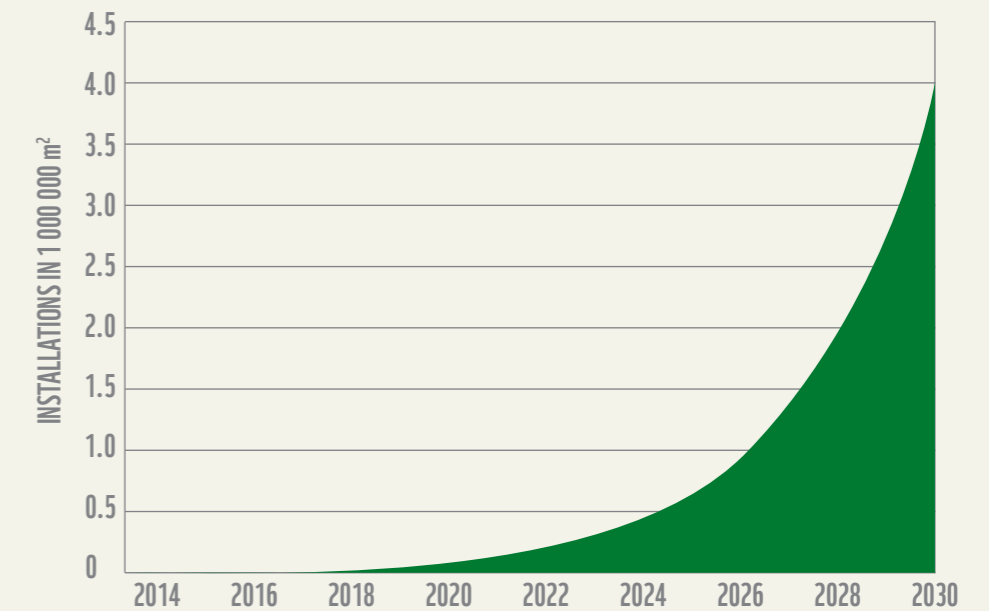

SOURCE: SA-STTRM DISCUSSION DOCUMENT (SOLTRAIN, 2015: 23)³²

31 Note this is not exclusively industrial or food and beverages. For the full STTRM vision see Figure 23 in the appendix.

32 Full vision of all components shown in Figure 23 in Appendix 3.



© SHUTTERSTOCK.COM

In the textile industry there is a high potential for solar heating to be used in washing, bleaching and dyeing processes.

POTENTIAL FOR SELECTED INDUSTRIES

This section discusses industrial energy use before focussing on the two industries shown to be have significant potential for solar thermal uptake, namely agri-processing (food and beverages) and textiles. The potential in these two industries is quantified in terms of potential market and the subsequent carbon savings. To confirm that solar thermal can and has been utilised in these industries, international case studies are also presented for each industry.

Industry as energy user

Industry is one of the largest energy users in the country making up 36%³³ of energy use³⁴ (IEA, 2016). Industry has also been identified as a key area for solar thermal uptake internationally through the establishment of the Solar Heating & Cooling (SHC) *Task 49: Solar Heat Integration in Industrial Processes* of the International Energy Agency (IEA), highlighted earlier.

At a very broad level, the potential for solar heat is clear as half of all final energy needs within South Africa is for heat (Holm, 2015). As previously indicated, solar heat is best suited to supply processes that require low temperature heat (160°C)³⁵ (AEE Intec, 2009, p. 77). Table 3 highlights some of the industries that have identified as having potential for solar heating.

33 The more detailed but slightly dated SATIM data has: industry using 46%, transport using 29% and residential accounting for 15% (Energy Research Centre, 2014).

34 The other large energy users being: transport (25%) and the residential sector (23%).

35 While there is no uniform agreement on the exact temperature level below which processes are seen as low temperature, this report considers 160°C, although some consider up to 450°C as low temperature.

Table 3: Industrial sectors and processes with the highest potential for solar heating

Industrial sector	Total Annual Energy Demand in PJ (DoE 2012)	Total Annual Energy Demand in PJ (SATIM 2006)	Process	Temperature level (°C)
Food and beverages	7.4 total (no coal) ³⁶ 4.8 gas 2.6 electricity	58.8 32.4 coal 15 electricity 1.4 gas 10 biomass	drying washing pasteurising boiling sterilising heat treatment	30–90 40–80 80–110 95–105 140–150 60–90
Textile industry	10.8 total 10.3 gas 0.5 electricity	None provided (154 for other industries)	washing bleaching dyeing	40–80 60–100 100–160
Chemical industry	86.3 total (including petrochemical)	145.7	boiling distilling various chemical processes	95–105 110–300 120–180
All sectors	2 657.4 total	2536	preheating of boiler feed water heating of production halls	30–100 30–80

SOURCE: INDUSTRIAL SECTORS AND PROCESSES FROM AAE INTEC (2009: 77) AND ENERGY DEMAND FROM DOE ENERGY BALANCE (DEPARTMENT OF ENERGY, 2013) AND SATIM (ENERGY RESEARCH CENTRE, 2014)

This paper focuses on lower temperature applications, as they are believed to be easier to implement. Hence the focus on the agri-processing (food and beverages) and textile industries. Although the chemical industry has higher temperature (above 160 °C) processes, there are some low temperature applications, showing that solar thermal is applicable more broadly than this paper's focus. The energy used by the agri-processing (food and beverages) and textile industries is quite small in terms of total energy use: 0.2–2.3% and 0.4%, respectively. However, this is broadly aligned with their relative size in the economy, 2.6% and 0.3% respectively, in terms of GDP.

Agri-processing

Agri-processing in this report, refers to the food, beverages and tobacco industry.³⁷ Solar heat integration is ideal for food and beverage processing as most (77–79%) of these industrial sectors' energy needs are for heat (Lampreia, 2014 & Energy Research Centre, 2014).

In addition, agri-processing is set to receive support from a number of government policies. These include the proposed Agri-park programme of the Department of Agriculture, Forestry and Fisheries (DAFF) and the Department of Rural Development and Land Reform (DRD&LR). This programme aims to establish an Agri-park as agricultural business hub in each of South Africa's district municipalities and R2 billion has been committed in the 2015/16 financial year to support rollout of this programme. Agri-processing has also been identified as

³⁶ This is known not to be true and thus the DoE estimate is likely an underestimate.

³⁷ It could be considered more broadly to include other industrial sectors based on agricultural resources such as textiles, leather and wood products (Statistics South Africa, 2012).

a strategic industry for government support by the Industrial Policy Action Plan (IPAP) of the Department of Trade and Industry (2016).

Agri-parks as well as new and expanded facilities as result of the expansion of agri-processing both offer potential for solar thermal installations. Retrofitting also offers additional potential, although the costs of retrofits may be higher. The potential for solar thermal uptake in food and beverages is clear, with 43% of installations internationally falling in this category.³⁸ Some of the largest installations are highlighted in the next section. South African industrial-scale installations (Table 2) also show a similar share of agri-processing installations.

Agri-processing: international case studies

In the international SHIP database, there are 73 installations in the food (53) and beverage (20) industry, showing that application of solar thermal in this industry is widespread. Solar thermal systems of differing sizes have been installed in a range of processes, in several countries as shown in Table 4 which presents the largest 11 systems in the industry.

³⁸ 31% and 12% respectively, see Table A1 in Appendix 1 for a full list of installations by industrial sector.

Table 4: Largest 11 solar thermal systems in food and beverages industry from SHIP database

Industry	Installer	Beneficiary/ Client	Process	Country	Collector	Installation year	Size (m ²)	Storage (m ³)
Beverage	S.O.L.I.D. GmbH	Gatorade	General process heat	USA	Flat plate	2008	3 793	114
	AEE INTEC, Sunmark	Goess Brewery	Mashing	Austria	Flat plate	2013	1 375	200
Food	Viessmann, Sunoptimo	Bonilait Dairy	Cleaning	France	Flat plate	2014	1 500	30
	S.O.L.I.D GmbH	Fleischwaren Berger	Cooking	Austria	Flat plate	2013	1 067	60
	Abengoa Solar	Frito Lay	Frying	USA	Parabolic trough	2008	5 068	1
	-	Milma dairy	Pasteurisation	India	Flat plate	2003	1 440	60
	ZEN-Solar	Perfetti van Melle	General process heat	Netherlands	Flat plate	1998	2 400	95
	FLS Energy	Prestage Foods	Cleaning	USA	Flat plate	2012	7 804	946
	Aalborg CSP	Sundrop Farms Port Augusta	Various*	Australia	Other	2010	52 000	-
	FAFCO	Stapleton-Spence Fruit Packing	Rehydration	USA	Unglazed	2012	2 637	50
Sol Energy Hellas S.A	Tyras S.A.		Greece	Flat plate	2001	1 040	50	

* Heating greenhouses in winter and during cold summer nights, desalinating seawater from the nearby Spencer Gulf, and periodically running a steam turbine to produce electricity

SOURCE: AEE INTEC, 2016

Estimating agri-processing potential in South Africa

With 77–79% of the food and beverage industry’s³⁹ energy consumption being a demand for heat, it is a key industry to consider solar thermal integration (Lampreia, 2014; Energy Research Centre, 2014). Table 5 provides estimates for the potential for solar thermal in the food and beverages industry in South Africa and the assumptions used to reach this estimate.

To calculate the potential within South Africa, first the energy use of the industry is considered. As two datasets (SATIM, 2006; DoE 2012) are available for energy use in the food and beverage industry, they are both considered in column 1. Next, the share of this energy that is used for heat is considered (per fuel type) (presented in column 2). Column 3 and column 4 provide details of the assumptions made, namely, what share of the energy used for heat can be replaced economically by solar integration (column 3); and when solar heat is integrated, what share of the heat will actually be replaced by solar energy (i.e. the solar fraction), (column 4).

³⁹ Referred to as ‘food & tobacco’ in Lampreia (2014).

This enables an estimate to be made of what share of total energy solar thermal would be able to provide (given in both PJ and GW per annum in column 5 and 6, respectively). Finally, using an effective solar irradiance of 1 000 kWh per annum (based on a 50% efficiency of collectors and a solar irradiance of 2 000 kWh per annum⁴⁰), the installation potential in m² is shown in the seventh and final column.

Given the differences between the datasets for total energy consumption, this results in a potential range from 483 000 to 3 758 000 m² solar thermal installation in South Africa providing 425 GWh to 3 758 GWh of thermal energy per annum. The significant variation is a consequence of the differences between the data sources. The DoE energy balance excludes coal use within the food and beverages industries. The use of coal in boilers is widespread in these industries. Thus, the SATIM data is likely to be a better reflection of reality and thus the potential for solar thermal is likely to lie closer to the higher end of the range.

Table 5: Potential for solar heat in agri-processing

	Total food & beverage energy use (PJ / annum)	Energy used for heat (PJ / annum)	Share can integrate solar thermal economically ⁴¹	Solar fraction	Solar thermal potential (PJ per annum)	Solar thermal potential (GWh per annum)	Solar thermal potential ⁴² (m ² installations)
DOE 2012	7.4 total 2.6 electricity 4.8 gas	5.1 total 10% of electricity all gas	50%	60%	1.53	425	425 000
SATIM 2006	58.8 total 32.4 coal 15 electricity 1.4 gas 10 biomass	45.3 total all coal 9% of electricity all gas all biomass	50%	60%	13.59	3 758	3 758 000

SOURCE: AUTHORS’ CALCULATIONS AND ASSUMPTIONS

GHG emissions savings from solar thermal in agri-processing

Importantly, increased uptake in solar thermal can result in significant GHG emissions savings as is evident from the estimates presented in Table 6 (Details on the emission factors used for different fuels is provided in the footnotes to Table 6). The emissions savings potential for the uptake of solar thermal in agri-processing is in the broad range of 110 000–940 000 tonnes of CO₂e. The large difference in potential carbon savings is clearly due the inclusion of coal (which is a particularly carbon intense fuel) in the food and beverages estimated of the SATIM model, while being excluded from the DOE dataset. As the SATIM model is the more detailed (and more consistent with known practice), the real savings potential is expected to be in the upper end of this range.

⁴⁰ For reference, Stellenbosch’s annual tilted irradiance is approximately 2148 kWh per m² per annum.

⁴¹ Share of energy provided by solar thermal system on average, based on SOLTRAIN guidelines of industrial process heating (SOLTRAIN, 2016).

⁴² Based on industry engagement of GreenCape’s energy sector desk.

Table 6: Potential GHG savings from solar heating in agri-processing

Data Source	Energy potentially savings per annum (from Table 3)	CO ₂ e savings (tonnes / annum)			
		Coal	Electricity ⁴³	Gas ⁴⁴	Total
DOE 2012	0.08 PJ electricity 1.45 PJ gas	-	23 117	87 806	110 922
SATIM 2006	9.72 PJ coal 0.45 PJ electricity 0.42 PJ gas 3 PJ biomass ⁴⁵	783 871	133 326	25 359	942 556

SOURCE: AUTHORS' CALCULATIONS AND ASSUMPTIONS

Agri-processing case study: Cape Brewing Company (CBC)

The Cape Brewing Company (CBC) is a brewing company located on the outskirts of Paarl. Previously the plant fulfilled all its heating needs using a paraffin boiler. Realising the abundance of solar energy in the area they installed a 120 m², (84 kW_{th}) solar thermal system that provides process heat for the beer brewing process and hot water for cleaning. While the panels were imported from Austria the storage was locally manufactured. The project received SOLTRAIN support through the Centre for Renewable and Sustainable Energy Studies (CRSES) who conducted a feasibility study for CBC and provided technical support in analysing the the range of bids (summarised in Figure 22) received in response to the tender.

The 120 m² flat plate collector feeds into a 10 000 litre storage tank for the brewery that produced 3 million litres of beer annually when the system was installed. The system has an annual solar yield of 105 600 kW_{th}. As backup, the existing paraffin boiler is used to ensure security of supply. The system makes use of a control methodology that allows remote monitoring of the system which allows some preventive maintenance (allows the identification of problems before they become evident) (E3 Energy, 2016).

43 Emissions factor for 1kWh of electricity: 1.06 kg CO₂e based on Ecoinvent database South African energy mix.
 44 Emission factor of 0.0605 CO₂e per GJ (3 significant figures).
 45 Only emissions from fossil fuels considered so biomass excluded from emissions.

Figure 14: CBC brewery's 120 m² flat plate collector array



SOURCE: SOLTRAIN, 2016

This project is the largest⁴⁶ within the SOLTRAIN Western Cape flagship district (SOLTRAIN, 2015; E3 Energy, 2016). As this was a SOLTRAIN supported project, the company received technical support in the writing of the tender documents and in evaluating their applicability. The project went to tender with aim of decreasing fuel costs by at least 50%. The winning bid had a payback period of six years and went beyond achieving the 50% limit by further optimising their system.

Textiles

While the textile industry in South Africa has suffered over the past 15 to 20 years, the downward trend appears to be reversing with the industry recently recording positive growth and increased employment (Business Day, 2015). In addition, the Department of Trade and Industry (2016) also identified the clothing and textile industry as a high priority industry due to its labour-intensive nature. While the textile industry has some processes which require higher temperature levels (above 160 °C), these are only found in the polyester sector, with the processes for the other seven fibre types requiring a maximum temperature level of 140 °C as shown in Table A4 in the appendix.

46 The other systems in the flagship include the different testing facilities at the Centre of Renewable and Sustainable Energy Studies (CRSES).

Textile industry: international case studies

In the international SHIP database there are 18 installations in the textiles (8), wearing apparel (2) and leather (8) industrial sectors, showing that application of solar thermal in this industry is widespread. Solar thermal systems of differing sizes have been installed in a range of processes, in several countries as shown Table 7 which lists some of the solar thermal installations in the textile industry.

Table 7: Solar thermal systems in textile industry from SHIP database

Installer	Beneficiary/Client	Process	Country	Collector	Year	Size (m ²)	Storage (m ³)
FLS Energy	Acme McCrary	Dyeing	USA	Flat plate	2010	743	1
SOLE S.A.	Allegro S.A. Children's Clothing Manufacturer	Cleaning	Greece	Flat plate	1993	70	3.5
Shenzhen Quir Solar Technology	High Fashion Ltd.	Bleaching	China	Flat plate	2007	13 000	900
SoloSolar & Grammer Solar	-	Textile production	Vietnam	Air collector	2012	480	-
GAROL	Harlequin	Painting	Spain	Flat plate	2002	47.15	5
Sunrain Co. Ltd	Jiangsu Printing And Dyeing	Printing & dyeing	China	Evacuated tube collector	2011	9000	
FOCO S.A.	Kastrinogiannis S.A.	Bleaching	Greece	Flat plate	1993	174	10
Smirro GmbH	Meiser Carl GmbH & Co KG	Other process heating	Germany	Parabolic trough collector	-	100	0.01
Thermax India	Purple Creations P Ltd	Ironing clothing	India	Dish concentrators	2013	480	
Inter Solar	Sharman Shawls	Bleaching	India	Flat plate	2015	360	8

SOURCE: AEE INTEC, 2016

Size of the textile industry opportunity

Based on energy use presented in Table 3, the potential for solar thermal systems in the textiles industry is calculated in Table 8. This shows a comparable potential to that of agri-processing (Table 5) and is based solely on the DoE energy balance due to the absence of SATIM data for this industrial sector. Accordingly, there might be an underestimation due to lack of consideration of coal use by the industrial sector.

The solar thermal estimate is done in a similar manner to that of the agri-processing industry, with the first column indicating the total energy used in this industrial sector (10.8 PJ) and then next column showing how much of the energy is used for heating (5.21 PJ). The assumptions, namely the share of the heating that can be supplemented with solar thermal energy (30%) and what share of the energy considered solar will be able to replace (60%), result in a potential solar thermal in terms of energy (0.94 PJ and 519 GWh) and installation area (519 000m²).

Table 8: Potential for solar heat in textiles

	Total food and beverage energy use (PJ / annum)	Energy used for heat (PJ / annum)	Share can integrate solar thermal economically	Solar fraction ⁴⁷	Solar thermal potential (PJ per annum)	Solar thermal potential (GWh per annum)	Solar thermal potential ⁴⁸ (m ² installations)
DOE 2012	10.8 total 0.5 electricity 10.3 gas	5.21 total 0.05 electricity all gas	30% ⁴⁹	60%	1.87	519	519 000

SOURCE: AUTHORS' CALCULATIONS AND ASSUMPTIONS

The potential for GHG emissions savings from the uptake of solar heating within the textile industry has been calculated in a similar manner to that for the agri-processing industry. Table 9 shows more potential than for agri-processing when considering the same data source (DOE 2012). As pointed out above, the potential might be higher if coal use of the industry is also considered.

Table 9: Potential GHG savings from solar heating in textile industry

Data Source	Energy potentially savings per annum (from Table 5)	CO ₂ e savings (tonnes / annum)			
		Coal	Electricity ⁵⁰	Gas ⁵¹	Total
DOE 2012	0.008 PJ electricity 0.93 PJ gas	-	2 414	112 546	114 960

Textiles case study: ACA Threads

ACA Threads (African Consolidated Agencies) is a Cape Town-based sewing thread manufacturer and supplier. Previously, all water heating relied on Heavy Fuel Oil (HFO) boilers. The application of the energy efficiency and renewable energy initiatives reduced the HFO requirements, which resulted in a reduction in fuel expenses. The solar water heating system directly provides hot water to a 30 000 litre hot water tank, which incorporates the heat recovery system and distributes hot water to the factory. The solar water heating system functions as a preheater for this storage which is stored at about 60 °C. The preheated water is then heated further, via existing HFO boilers, to the temperature needed by different processes. Most of the hot water is used for the dyeing of threads that requires a constant 135 °C.

⁴⁷ Share of energy provided by solar thermal system on average, based on SOLTRAIN guidelines of industrial process heating (SOLTRAIN, 2016).

⁴⁸ Using a conservative 1000 kWh per m² per annum effective radiation.

⁴⁹ Based on industry engagement of GreenCape's energy efficiency sector desk and scaled down for textiles due to solar thermal deemed to be most applicable only when dyeing.

⁵⁰ Emissions factor for 1 kWh of electricity: 1.06 kg CO₂e based on Ecoinvent database South African energy mix.

⁵¹ Emission factor of 0.0605 kg CO₂e GJ (3 significant figures).

The collector modules consist of 40 panels of evacuated tube type with a total collector aperture area of 156.4 m². The control system activates the solar pump once the temperature in the panels exceeds the hot water tank temperature. Fail-safe mechanisms are in place within the hot water system to prevent overheating and damage to the system.

Figure 15: ACA Thread's 156.4m² evacuated tube array



© ULRICH TERBLANCHE

SOURCE: ?????

ACA Threads is not measuring the savings from the solar water heaters independently. The savings includes all initiatives undertaken in the process. The initiatives, together with the solar system, resulted in a fuel reduction of 0.18 L/kg dyed product in a year. This translates to a financial saving of R 317 000 per year in fuel costs. The payback period for the solar thermal systems was estimated at 8 months when installed with the system performing better than anticipated.

The financial feasibility was made more attractive through the availability of grant funding through the Production Incentive Programme (PIP) as part of the Clothing and Textiles Competitiveness Programme (CTCP) by the Department of Trade and Industry (dti). The PIP consists of an Upgrade Grant Facility, which is meant to focus on competitiveness improvement. It is a market neutral incentive offered to industrial sub-sectors, such as clothing and textile manufacturers, resulting in an incentive benefit equal to 7.5% for the year based on a company's Manufacturing Value Addition (MVA) (Industrial Development Corporation, 2016)⁵².

52 The Production Incentive Programme (PIP) is still available to companies in the qualifying sectors.

The availability of grant funding made the implementation of such systems more feasible. However, one of the key drivers identified by ACA Threads is buy-in from management. Long-term feasibility of such projects is unlikely to be realised without a driving force from within the company and a key responsible person.

Textiles case study: Migra Group

This section highlights the results of a feasibility study of the applicability of solar thermal to Migra Group conducted by CRSES. Migra Group is a company located in Epping Industria, Cape Town that undertakes commission dyeing and finishing of most of the cotton yarn and knitted fabrics and forms of the textile industry in South Africa.

Migra uses steam for heating water during dyeing and finishing processes, which operate at temperatures ranging from 40 °C to 130 °C. The steam is generated by an HFO boiler. The steam generation processes requires large amounts of water (4.1 Mil litres per annum) and fuel (202 MWh per annum), making it an ideal candidate for solar thermal integration as it is likely to have significant cost-saving potential.

Migra currently uses return condensate from their dyeing and finishing process, with a temperature of 60 – 80 °C, as a heat recovery system to preheat water. This also supplies 45% of the 7.9 Mil litres of water needed for steam per annum, with the remaining 4.1 Mil litres provided by municipal water at a temperature of 15 – 20 °C. The two water sources are allowed to mix in a 10 000 L stainless steel storage tank before being fed into the boiler.

The study identified the potential of preheating the municipal water prior to being stored in the tank and fed into the boiler. A solar water heating (SWH) system was designed to preheat the municipal supply to at least 60 °C, before being fed into the existing 10 000 L storage tank. This would reduce the HFO used to generate steam and the associated costs as well as reduce energy losses in the storage tank. The proposed SWH system is shown in figure 16 below.

Figure 16: A schematic of Migra's system

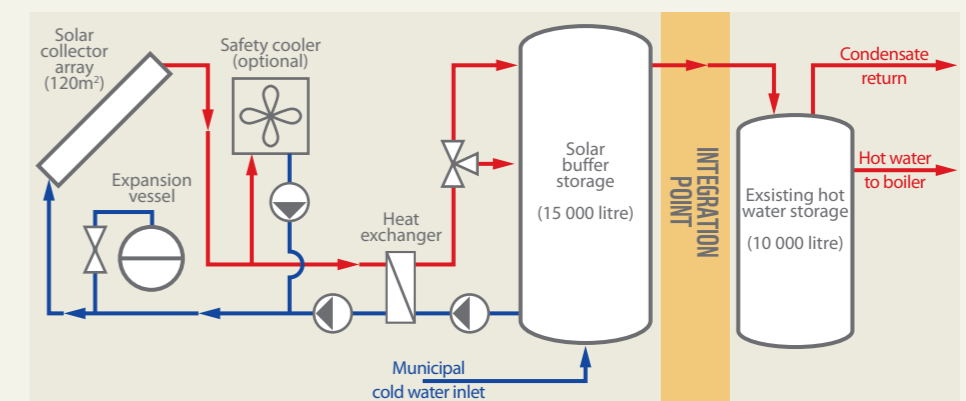

SOURCE: ULRICH TERBLANCHE AND ANGELO BUCKLEY

The proposed system consists of a 120.7 m² collector array that absorbs solar irradiance and transfers the heat through a heat exchanger to a 15 000 litre hot water buffer storage tank. Water from the buffer tank is transferred to existing storage when above 60 °C during operation of the boiler. The designed system would have a solar fraction (SF) of 58%, meaning it could provide 116 030 kWh of Migra's heat demand for heating the "make-up" water to 60 °C each year, and a solar gain (SG) of 961.2 kWh/m² per year.

The proposed system has an estimated total cost of R 832 200. Migra currently pays R 4.56 / litre for the HFO and lube oil mixture, which used to operate the boiler. Considering a lifespan of 20 years and a financed 70% by a loan of 10 years the project has an expected payback of approximately 9.5 years with an IRR of 19%. The system would produce energy at a LCOH of R 0.69 / kWh over its 20-year lifetime. The system would generate a total saving of R 3 893 000 for Migra over 20 years, offsetting 14 906 litres of HFO fuel per annum. Subsidies and financial schemes have the potential to significantly improve the financial outcomes of the project.

Overall potential

The overall potential in the perspective of the SA-STTRM vision for large solar systems is 4 000 000 m² by 2030 (Figure 13). The estimated potential in the textiles and agri-processing industries of between 944 000 m² (519 000 +425 000) and 4 277 000 m² (519 000 +3 758 000) initially seems to align with the vision. However, as the large-scale installations in the SA-STTRM include all industries not just those discussed here, as well as commercial and multifamily residential installations, this could indicate that the SA-STTRM vision underestimates the potential for solar thermal uptake at industrial scale and the expected 40 000% increase in total installations over 15 years (on an installed area basis) (see Figure 13) not as over-optimistic as it may at first seem.

KEY DRIVERS OF SOLAR THERMAL IN SOUTH AFRICA

There are six key drivers for the uptake of solar thermal in South Africa:

- increasing energy prices,
- carbon emission savings potential,
- energy efficiency cost savings and incentives,
- cost-effectiveness of new build,
- innovative contracting solutions and
- the Southern African Solar Thermal Training & Demonstration Initiative (SOLTRAIN)

Increasing energy prices

South African industries are faced with electricity prices that are increasing at a significantly faster rate than average prices in South Africa, as demonstrated in Figure 17 below. Figure 17 compares the consumer price index (used as a proxy indicator for the average price⁵³) and an index of the average National Energy Regulator (NERSA) approved electricity tariff increases (i.e. electricity price) from 2004 to 2015. The price of electricity has increased by more than 400% over the last decade. These price increases drive the consideration of alternatives to electricity.

⁵³ Consumer Price Index (CPI) tracks the average cost of an indicative basket of goods and is used to measure inflation. Inflation is the general rise of prices, or fall in value of money.

Figure 17: Electricity price index and consumer price index (2004 base year)

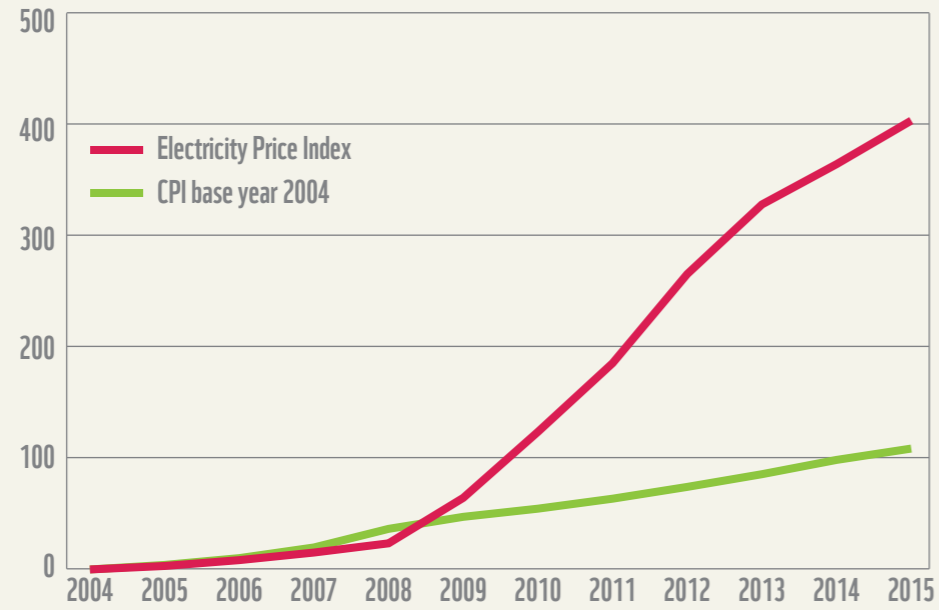

SOURCE: AUTHOR'S CALCULATIONS⁵⁴

Cost comparison of thermal to existing thermal systems

The financial feasibility of implementing solar heating is largely dependent on the cost of the fuel replaced. This is shown clearly in Figure 18 and Figure 19, which present the internal rate of return (IRR) and payback period, respectively, for a 0%, 6% and 12% increase in price for the replacement of a range of fuels.

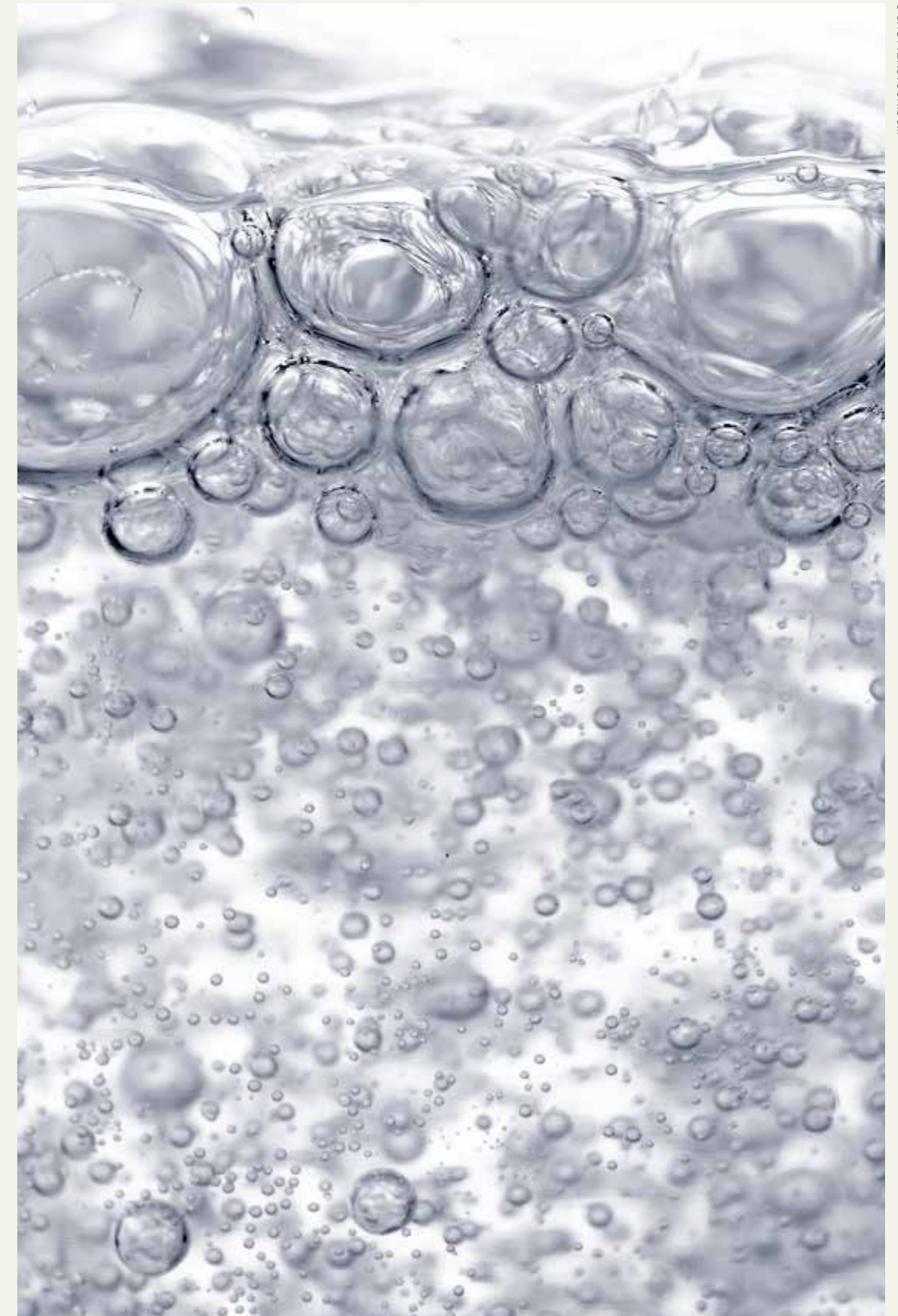

© SHUTTERSTOCK.COM

Solar heat can be integrated into industrial processes using different heat mediums – heating of water or air, or through steam generation.

⁵⁴ Calculations using NERSA approved average tariff adjustment as per published tariff book indexed to base year 2004 (Eskom, 2016) and historical Consumer Price Index (CPI) (StatsSA, 2016).

Figure 18: Internal rate of return (IRR) for a current large-scale system with a service life of 20 years replacing different conventional fuels

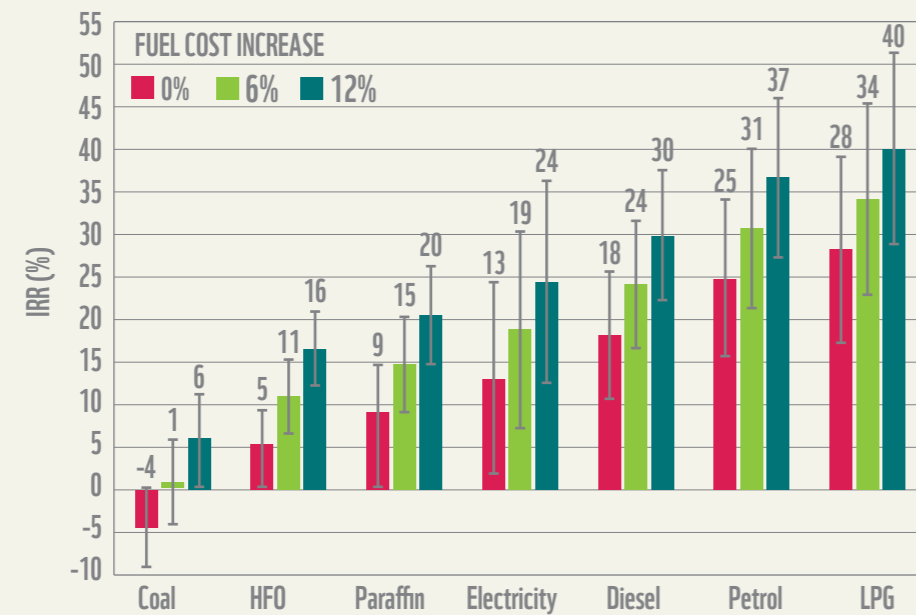

SOURCE: JOUBERT, ET AL. (2016: 820)

Figure 19: Payback periods of current large-scale solar thermal system when substituting conventional energy sources⁵⁵

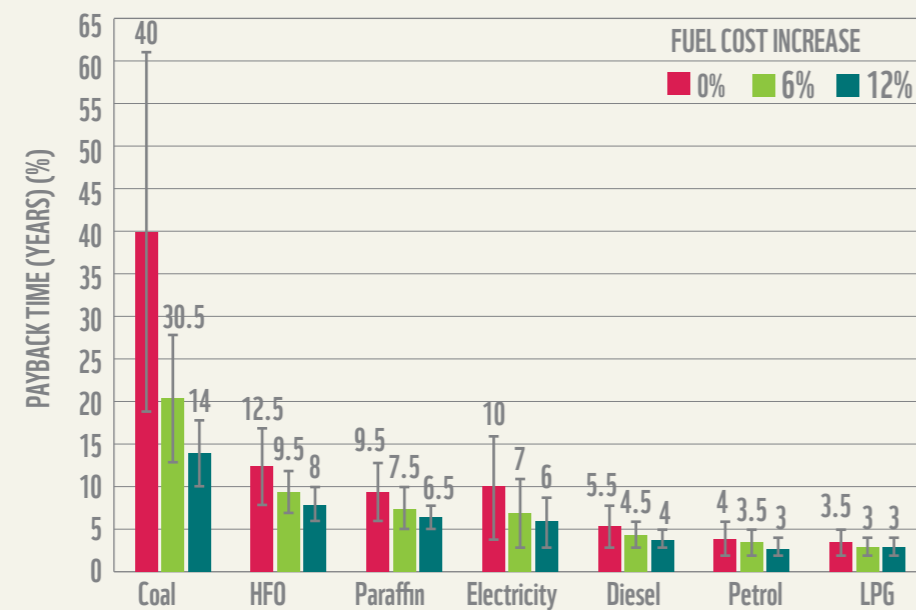

SOURCE: ?????

⁵⁵ For a system that costs 603 EUR/m².

From these figures it is clear that whilst substituting coal with solar thermal energy is not financially attractive at present, it is worth exploring for all the other fuels considered, specifically heavy fuel oil (HFO), paraffin, electricity, diesel, petrol and liquefied petroleum gas (LPG). This is evident from an IRR above 10% for all fuels (except coal) with a conservative 6% price rise (Figure 18). Furthermore, payback periods are in the range of 5 years for paraffin, electricity, diesel, petrol and LPG (Figure 19).

It is worth noting that the return and payback period for the same system varies according to application. For example, while the average payback period for electricity systems with no increase in electricity price is 10 years, there are cases⁵⁶ where payback will be less than 5 years, even with no electricity price increases.

Switching to solar thermal will not only mitigate against future increases in fossil fuel costs, but also against the future volatility thereof. This will aid in long-term planning as the solar thermal yield and maintenance costs are relatively constant, while the oil price and its related fuels (HFO, paraffin, diesel, petrol & LPG) are inherently volatile. It is also worth noting that the business case for substituting these fuels (including coal) will significantly improve once the anticipated carbon tax is implemented.

Greenhouse gas emissions savings

In addition to the rising energy costs, South Africa, under the Copenhagen Accord, has committed to reduce its greenhouse gas (GHG) emissions by 34% by 2020 and 42% by 2025. As 85% of GHG emissions in South Africa are attributable to energy, increasing the uptake of renewable energy, such as solar thermal, is critical to ensuring South Africa meets its commitment (Witi & Stevens, 2013). As solar thermal systems can be a direct substitute for fossil fuels used to generate heat, it is a key carbon emission savings opportunity.

South Africa's proposed carbon tax of R120 per tonne CO₂e, offers a clear incentive to switch to technologies that result in carbon emission savings. This would translate to an additional cost saving of R13.3 Million and R13.8 million per annum for the agri-processing and textile industries, respectively, if the full potential (see Table 6) were to be realised.

Energy efficiency incentives

To ensure a profitable transition, companies considering utilising more sustainable energy sources are able to utilise the government's income tax rebate system as part of the National Energy Efficiency Strategy (NEES). Tax rebates are possible for the implementation of energy efficiency projects through the 12I⁵⁷ and 12L⁵⁸ tax rebates programme.

⁵⁶ Shown by the error bars on the graphs.

⁵⁷ Overseen by National Treasury.

⁵⁸ Managed by SANEDI.

12I rebate supports investments in manufacturing assets that: (a) enable energy efficiency and cleaner production, and (b) where the asset values are between R50 million and R900 million for new projects (greenfield) or between R35 million⁵⁹ and R550 million for expansions (brownfield) Additional support is also available to projects that take place in a special economic zone (SEZ).⁶⁰

The 12L rebate provides a rebate on energy savings through the implementation of energy efficiency measures. This means that energy savings achieved by generating energy from renewable energy does not qualify for the 12L rebate. Solar thermal installations could, however qualify for the 12B tax incentive, allowing for accelerated depreciation of the capital cost for tax purposes.

Cost-effectiveness of new build

The opportunity for solar thermal systems is clearer for new expansions, especially if new plants to enable that solar heat are fully integrated. New developments that incorporate solar systems from the design stage will be more cost effective as certain aspects of buildings cannot be adjusted, or only adjusted at great cost, post-construction. Some of the aspects to consider are, the orientation of the roof space to capture the most heat as well the angle of incidence of the roof that optimises energy capture. On already existing buildings these can be overcome to some extent through additional strengthening or platforms, but this will increase the cost of the installation.

New buildings are also encouraged to consider solar options due to the revised building standards⁶¹ that require buildings to comply with a number of energy efficiency requirements, including that at least 50% of the annual hot water has to be heated by a renewable energy source for conventional buildings. Solar water heaters have been proven to be the most cost effective option for the majority of new residential developments since the new building standard was introduced in 2011. While the building standards are not aimed at process heating, the SA-STTRM has highlighted the possibility of mandating preheating for agri-processing in a similar manner.

Innovative contracting solutions

One of the drivers for renewable energy uptake, including solar heating, has been the establishment of energy service companies (ESCOs). ESCOs typically install (renewable) energy and energy efficiency technologies (including solar thermal) for companies and then retain ownership of the assets while selling energy to the company at a lower cost than the company originally paid. Alternatively, ESCOs remove investment risk through energy performance contracts whereby a minimum decrease in energy cost is required or the ESCO is penalised, thus limiting the downside risk to companies. As ESCOs are able to specialise in renewable energy and

59 Or the lesser of R50 million or 25% of the expenditure incurred to acquire assets previously used in the project.

60 For a list of established and proposed SEZs see: http://www.dti.gov.za/industrial_development/docs/SEZ_brochure.pdf.

61 SANS 10400-XA and SANS 204 for commercial and residential buildings.

energy efficiency, they are able to support industries that do not have the ability to consider the most economic manner to meet their energy needs.

Traditional financing institutions (e.g. banks) have also come to realise the strong business case associated with renewable technologies. They have developed financing packages focussed on increasing renewable energy uptake through, amongst others, lower interest costs for specific renewable energy investments (e.g. Nedbank Fair Share 2030). There has also been support made available through specific projects aiming to support renewable energy uptake such as the Sunref line of credit, provided by Agence Française de Développement (AFD), that has already enabled a number of renewable energy projects, including some solar thermal, by partnering with traditional financiers (Agence Française de Développement, 2015).

The Southern African Solar Thermal Training & Demonstration Initiative (SOLTRAIN)

The Southern Solar Thermal Training & Demonstration Initiative (SOLTRAIN) is a regional initiative to support the solar thermal development in the SADC region. It is funded by the Austrian Development Agency and OPEC Fund for International Development (OFID). SOLTRAIN is currently in its third phase with substantial progress made in the first two phases.

Some of key successes to date include: more than 120 people trained in solar thermal systems and 127 solar thermal demonstration systems installed across residential, commercial and industrial scale across SADC. These results are important as one of the constraints to developing a solar thermal industry is ensuring that potential uptakers understand solar thermal systems. For industrial applications which are typically custom-designed, knowledge of solar thermal design is fundamental. SOLTRAIN has thus also had workshops aimed at industrial scale applications specifically.

The demonstration systems account for 522 tonnes of CO₂e of GHG emissions being avoided (SOLTRAIN, n.d.). These demonstration systems also function as key case studies to show that the technology is applicable to local conditions.

At a more strategic level, SOLTRAIN has helped develop solar thermal roadmaps for South Africa, Namibia and Mozambique. It also provided support in 2016 for the upgrading of Stellenbosch University's collector test facility to European standards so that commercial tests could successfully be performed.

The current third phase of SOLTRAIN (2016–2019), building on the success of the previous phases, aims to train 500 persons on the design, installation and maintenance of solar thermal systems. It also aims to have an additional 70 solar thermal systems installed, in operation and quality checked. To achieve this objective, SOLTRAIN has funding available to subsidise the installation cost of solar thermal systems within flagship districts. This funding will be used to co-fund up to 50% of installation costs to ensure the 70 solar thermal systems are realised within the flagship areas⁶².

62 For more information including application forms, contact Karin Kirtzinger (karink@sun.ac.za).

KEY BARRIERS TO SOLAR THERMAL

In spite of the drivers for solar thermal uptake, there are a number of barriers hindering the development of the solar thermal market. These barriers include knowledge of solar thermal and its relative complexity. There are practical limitations to solar thermal, as it is only applicable in certain instances.

The cost of solar thermal systems in South Africa which is linked to the market being relatively underdeveloped, in part held back by a requirement for systems (rather than component) testing to comply with quality standards in South Africa. Related to the underdeveloped market is the difficulty companies experience in finding funding for solar thermal systems that financiers lack experience with and thus are not able to price risk-effectively.

Knowledge and relative complexity

While solar photovoltaics (PV) has become more prevalent and more easily recognised, solar thermal has yet to achieve a comparable visibility. Solar PV can provide electricity for any process or energy need. In contrast, solar thermal only provides heat energy and is generally optimised for a specific temperature. This limits its adaptability as processes change in industry over time. Furthermore, solar thermal systems have to be specifically designed and installed per site as an integrated system. This is to ensure that there is relatively equal flow within the system, as hotspots on collectors could cause steam buildup and damage to the system.

However, the complexity of solar thermal relative to solar PV is offset to some extent by the higher energy output per area. Solar thermal is especially applicable when roof space is limited. To the disadvantage of solar thermal, potential uptakers in industry are generally unaware of this greater energy efficiency and do not take it into account when making investment decisions.

Given the relative complexity and lack of flexibility of solar thermal systems (generally optimised for a specific temperature level), as indicated earlier, they are best considered in conjunction with energy efficiency, to limit the risk of changes to the process system restricting the long-term effectiveness and usefulness of solar thermal (SOLTRAIN, 2016).



© STELLENBOSCH UNIVERSITY, CRSES



A 120 m² flat plate collector feeds into a 10 000 litre storage tank at the Cape Brewing Company. The solar thermal system provides heat for the beer brewing process and hot water for cleaning.

Practical limitations

Solar thermal systems are not universally applicable, with some sites being more suitable than others. While solar thermal systems are able to store some heat, increased storage results in higher costs. Accordingly, solar heat will be most applicable to processes that require heating during the day. Solar thermal will also only be applicable to companies that have space to implement solar thermal systems either with applicable roof space or ground space. Where solar thermal systems are retrofitted, the existing structure might present challenges as it may not be designed to carry the weight of solar thermal systems or be orientated incorrectly.⁶³ The required reinforcing or support structures could add to the cost of projects.

These physical limitations can restrict the installation of solar thermal systems. However, the significant solar resources of South Africa (shown in Figure 1 and Figure 2) show that there is an abundance of solar energy. The high solar irradiation means that solar collectors will have the ability to generate a substantial amount of energy before considering the losses mentioned above (e.g. from shading or less optimal orientation). This means that while these may limit the energy produced by a system, they may still produce enough heat to remain a viable option.

High cost of solar thermal / infant industry in South Africa

One of the key constraints to greater uptake of solar heating in South Africa is the relative high cost of these systems compared with systems elsewhere in the world. As shown in Figure 20, South African systems are not cost-competitive. (In Figure 20, the specific cost of systems is shown by the box plots and the levelised cost of heat (LCOH) is indicated by the green diamonds and accompanying light green range). This high cost is particularly notable as the South African system is the largest considered in the comparison and larger systems would be expected to have a lower cost per m² as they achieve economies of scale.

It is also worth noting the high variation in systems costs in South Africa (the wide range of the box plots) in comparison with other countries. This indicates that the industry has yet to fully establish the cost of solar thermal systems. This also makes it difficult for companies that want to consider solar thermal as they are likely to receive a wide variety of cost estimates. This challenge is confirmed by the range in bids received by the Cape Brewing Company (CBC) – see Figure 22 – which is the case study discussed on page 36.

In addition to the relatively high cost of solar thermal systems, a backup energy supply is also needed to ensure heating supplies are met when there is insufficient solar irradiance to produce the required heat. Current systems in South Africa are expected on average to provide 60% of heat (i.e. the solar fraction of heat demand is expected to be 60%) (SOLTRAIN, 2016). While this may sound low, for that fraction, the fuel cost over the system's lifetime is zero so it is important to consider both capital and operating cost over the life of the installation when considering financial viability.

⁶³ That needs to be north-facing to get maximum return in South Africa (south-facing in the northern hemisphere) as well as be able to bear the load of the solar thermal system.

Figure 20: Specific investment costs and levelised costs of solar thermal generated heat for large pumped domestic hot water systems

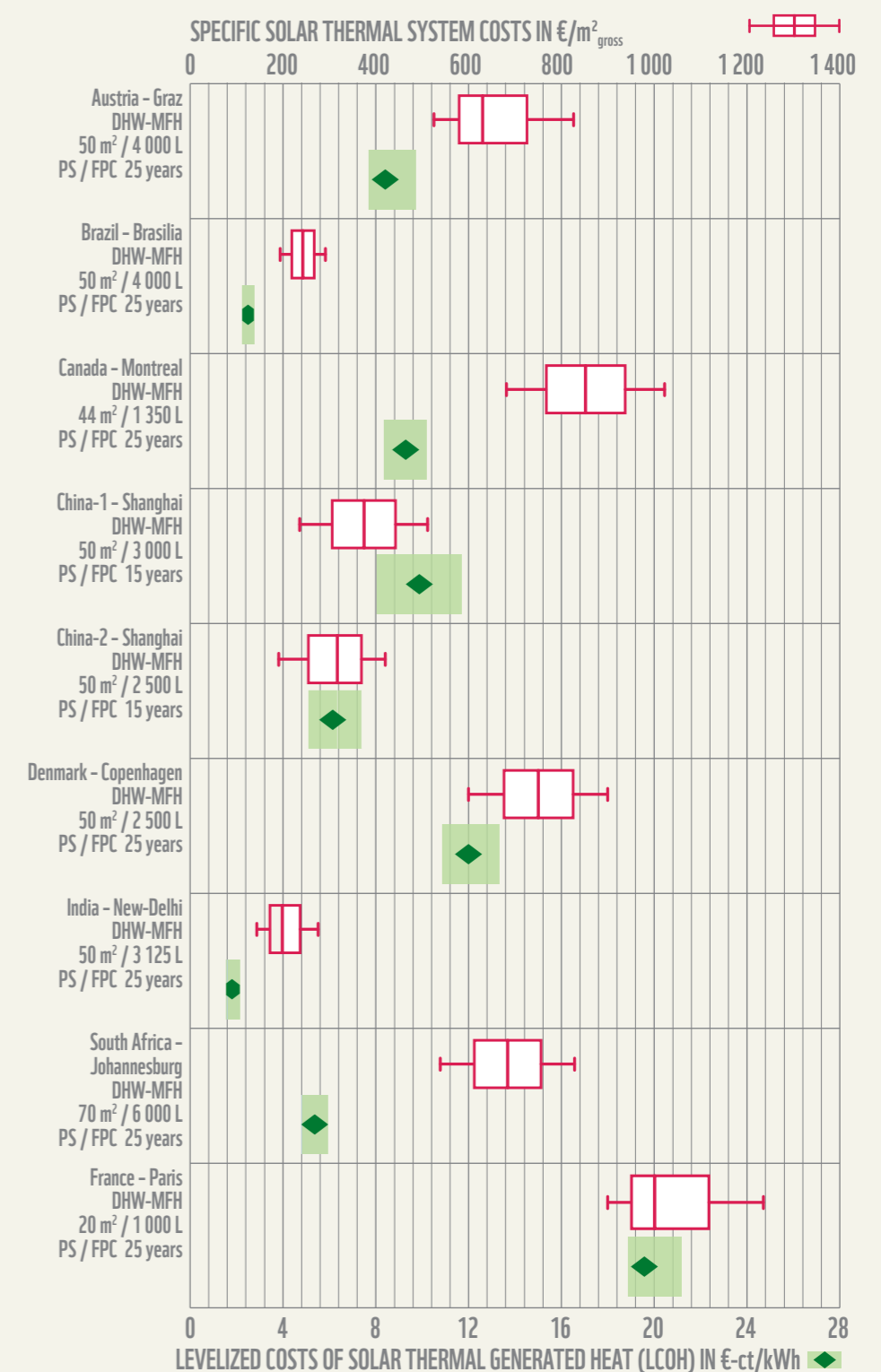

SOURCE: SOLAR WORLDWIDE (MAUTHNER, ET AL., 2016)

Infant industry

When an industry is unable to compete competitively with established industries in other countries, it potentially justifies initial government support such as subsidies. The aim of support for infant industries is to help the industry remain profitable until it is able to become cost competitive. The rationale is that the infant industry will learn and as there is more experience of production it will be possible to drive down the cost per unit. This is illustrated in a learning curve seen in Figure 21 below, which shows that as cumulative production increases, the cost of production per unit falls.

Figure 21: Learning curve for industry

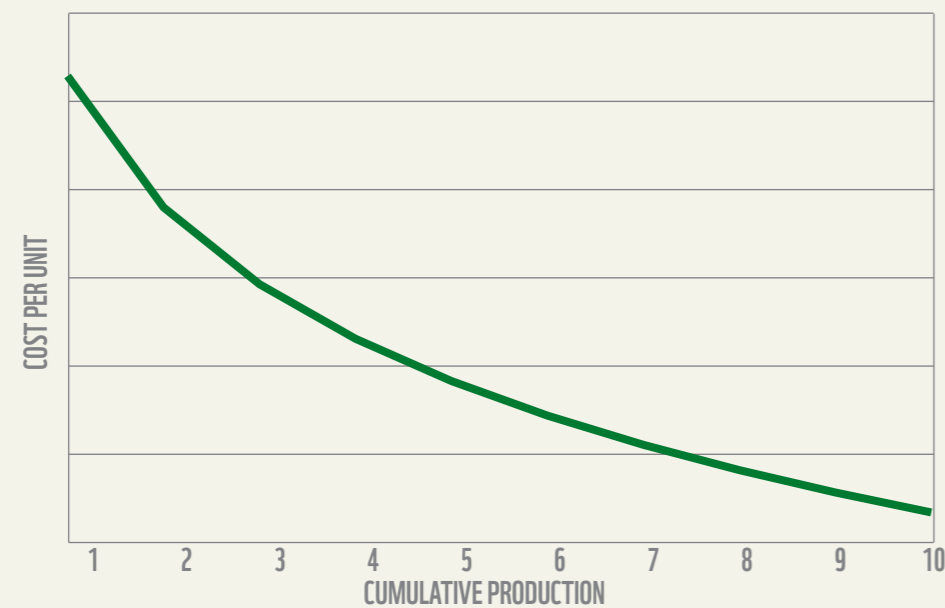

SOURCE: AUTHOR

As mentioned earlier, the wide range within the cost of systems (as shown in Figure 19) is reflective of a relatively underdeveloped market. Developed markets, such as India, have a cost for systems with limited to no space for uncompetitive higher prices in the market and thus have less variation in prices (see Figure 20).

The significant range in scope of bids provided by service companies in response to the Cape Brewing Company’s (CBC) request for proposal (shown in Figure 22) also highlights the lack of cost-competitiveness of the solar thermal industry in South Africa. This could be indicative of a lack of a clear understanding of solar thermal systems in South Africa. It also indicates the potential for cost reductions as the technology becomes more established. The range of proposals also highlights the difficulty companies in South Africa face when considering installing solar thermal systems: for one clearly defined project, there was a factor difference in the cost predictions and the high variation in costs seems to indicate that the industry is still learning about solar thermal technology⁶⁴.

⁶⁴ This wide variety of bids highlights the value of the SOLTRAIN support to evaluate the bids on a technology that the brewery was likely to not be as well versed in.

As the industry installs more units, it should move along the learning curve (Figure 20) and become more cost-competitive, in time becoming a well-established industry able to compete with established industries around the world. However, until that time, government support is required for this ‘infant industry’ as part of a range of interventions to encourage job creation and simultaneously reduce carbon emissions to address climate change. Such support could entail subsidies (for example the Section 12 income taxes) or import restrictions from competing countries (similar, for example, the import restriction from China to protect South Africa’s clothing and textile industry) or support in training of solar thermal installers.

Figure 22: Proposal comparisons and component breakdown from the CBC tender⁶⁵

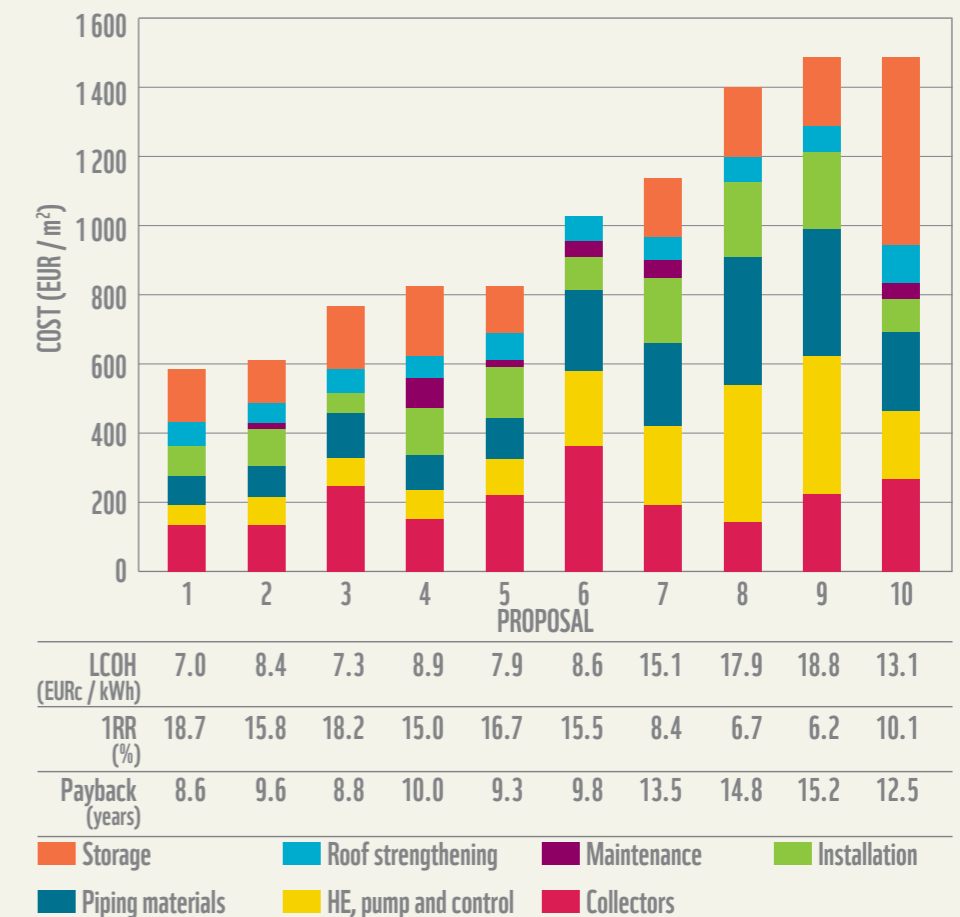

SOURCE: JOUBERT, ET AL. (2016: 815)

Strongly linked to the infant industry rationale is the lack of skilled people in South Africa able to support the uptake of solar thermal. While this is a key constraint,

⁶⁵ The figure uses September 2015 exchange rate of ZAR/EUR = 15.3. The table below the graph shows the calculated levelised costs of heat (LCOH), internal rate of return (IRR) and payback period.

it is being addressed in part by the Southern African Solar Thermal Training and Demonstration Initiative (SOLTRAIN) as discussed on page 49.

Requirement for systems testing for certification

One of the barriers to lower solar thermal system costs is the requirement for systems testing rather than component testing by the South African Bureau of Standards (SABS). Systems testing requires solar thermal systems to be tested and certified as a complete system which necessitates recertification of the entire system if a single component has been changed. For industrial systems, which are designed to purpose, this means that designers have to rely on internationally certified components, as no local component certification exists. This increase in costs (related to certification or imported components), in turn results in increased costs of the system, as well as inhibiting the development of local manufacturing⁶⁶.

In contrast, other countries such as Brazil, Canada, China, EU, India, Mexico, and USA allow component testing and certification (Hertzog, 2012, p. 10). Component testing allows greater competition as companies are able to focus on the production of individual components of systems, not just entire solar thermal systems. This will enable greater local manufacturing as companies are able to specialise and achieve economies of scale on certifiable sub-components. The ability to adjust designs and replace components also allows greater flexibility in design as individual components can be adjusted without needing to recertify the entire system.

Funding availability

As solar thermal technologies are relatively unknown to traditional financing institutions, it may be a challenge to obtain financing as easily as for other technologies or investments, especially as banks tend to be risk averse. To calculate the risk for a solar thermal project, banks require, amongst others, the resale value of solar thermal collectors and systems (which may be difficult to determine given the bespoke nature of industrial installations) and a realistic lifetime for these systems (which cannot be that readily predicted given the infant nature of the industry and variability in design).

Obtaining financing can be less of an issue for clients with strong balance sheets, which leads to creditworthiness. However, it limits the ability of smaller companies to consider solar thermal systems as they would not necessarily have the creditworthiness to secure a loan. Targeted funding (grants or favourable loans) and loan assurance (underwriting) for solar thermal systems could enable growth in the industry.

As solar thermal systems are generally considered to have a lifespan of the order of 20 years, the key limitation is matching longer-term returns to financing that is generally only available for a significantly shorter term (e.g. five years). This can be addressed by longer-term loans. Some banks have started to offer these to better match the returns and financing costs of green technologies, but the risk perceptions of solar thermal systems remain high.

⁶⁶ This is examined in detail in the publicly available report commissioned by GreenCape (Hertzog, 2012).

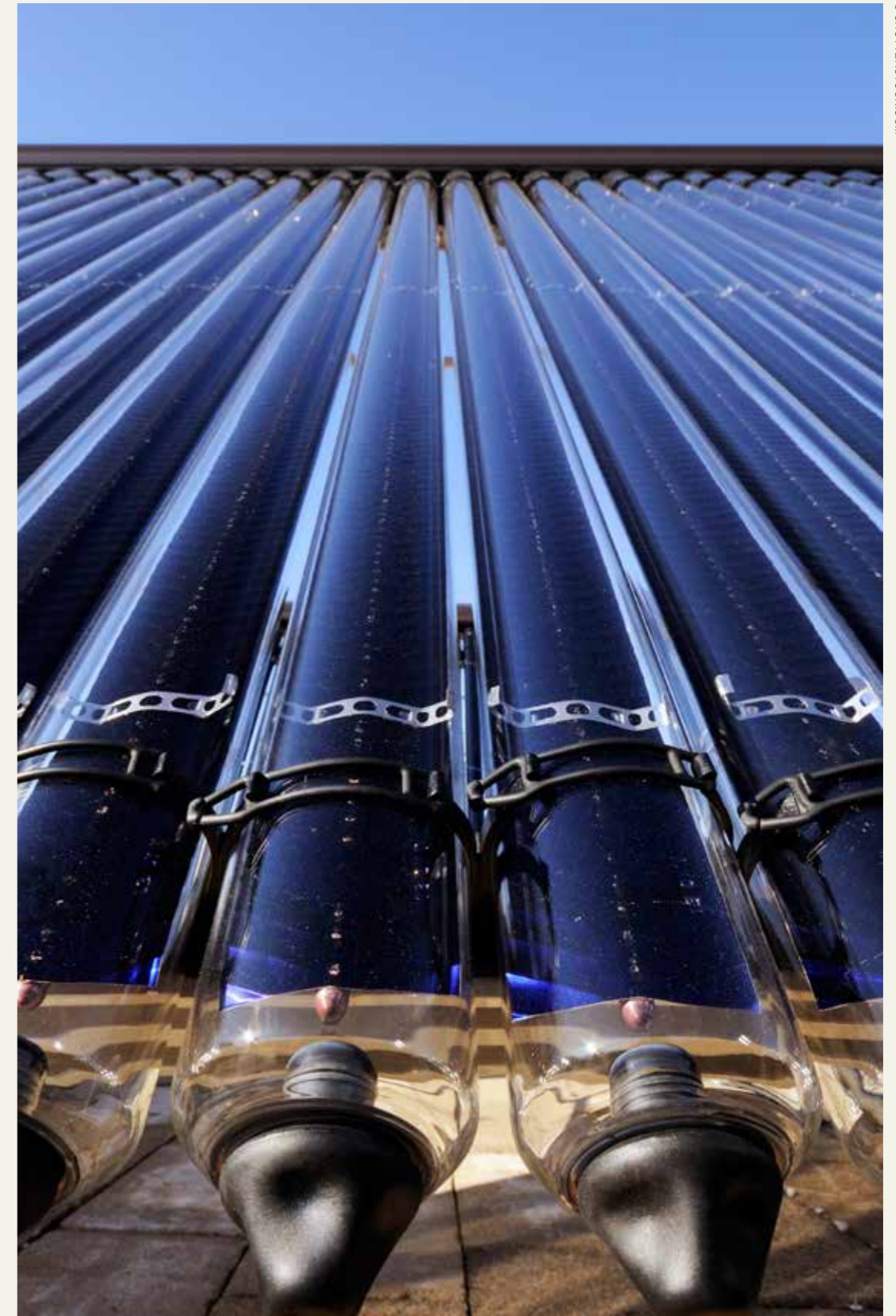

© SHUTTERSTOCK.COM

Heat from the sun can be 'captured' in a collector. This photo depicts a non-concentrating evacuated tube collector.

CONCLUSION

The analysis presented here has demonstrated that there is a clear opportunity for greater uptake of solar energy in general, and solar heating specifically, in South Africa. This is due to the solar potential of South Africa and its current development and carbon emission reduction ambitions in the face of increasing energy costs and a fossil-dominated energy mix.

The following industries have been shown to have specific potential:

- Agri-processing industry (425 000–3 758 000 m² providing 425 – 3 758 GWh of heat per annum, and carbon emission reductions of 110 922–942 556 tonnes CO₂e per annum)
- Textile industry (519 000 m² providing 519 GWh of heat per annum, and carbon emission reductions of 58 687 tonnes CO₂e per annum)

Key conclusions for industries utilising heat

The increase in solar thermal uptake for processing heating ultimately depends on the industry's willingness to consider alternative systems. The existing case studies show that it is possible, and the analysis presented indicates that the financial feasibility depends on the fuel that is replaced. This analysis suggests that it is financially viable for all energy sources, except coal at this stage, in spite of the high cost of solar thermal systems.

The financial case for replacing oil-based fuels will improve as energy prices rise and the proposed carbon tax is instituted. In addition, the financial case can be strengthened by making use of available support: for large projects, the income tax rebates are applicable, while small and medium enterprises can apply to SOLTRAIN for financial support.

Concerns about capital costs could also be overcome through the use of innovative contracting provided by ESCOs. This both reduces the risk of inefficient installations and removes or limits the capital cost burden of this relatively capital intensive intervention. The capital cost is taken up by the installer in return for a) a share in the energy savings with guaranteed savings limiting risk or b) selling the energy to the company utilising it (at a lower cost than the original supply).

While the business case can be made for solar thermal, the practical applicability of solar thermal also has to be considered. Not all sites will have a suitable space (roof or otherwise) to implement solar thermal. However, given the significant solar irradiation in South Africa, energy yields of systems may be high enough to be able

to remain feasible even with some limitations. So despite practical limitations, the business case may remain stronger than in countries with lower solar radiation.

A further consideration is the relative complexity of solar thermal compared to solar PV and limited ability to adapt⁶⁷ to future (heat) energy needs. Due to the lower flexibility, best practice suggests considering energy efficiency before solar thermal options. One of the key considerations is that installations would be more cost-effective on new plants (rather than retrofitting existing plants) as they can be optimised often without increasing overall costs (for example, by ensuring building is orientated for the best sunshine access for panels). This makes new plants that enable designs to maximise solar thermal efficiency a key opportunity for solar thermal uptake.

Key conclusions for solar thermal industry

Currently, the solar energy industry is relatively undeveloped which means there are significant opportunities to grow, with remarkable growth envisioned for the solar thermal industry by the South African Solar Thermal Technology Road Map (SA-STTRM). This study identifies the agri-processing and textile industries as key growth areas, as most of the energy requirements are for low temperature heat (below 160 °C).

Currently, solar technology is not well understood by most potential clients. This gap can be bridged through clear and transparent communication about the costs, benefits and practical implications of these technologies in order to promote more rapid uptake. In addition, the complexity and limited adaptability of solar thermal means that best practice would be to consider solar thermal in conjunction with energy efficiency to ensure long term feasibility.

Solar thermal systems involve significant capital costs. This can be addressed through ESCO service models removing the capital cost constraint as long as the ESCO has the required solar thermal knowledge. The capital costs can also be decreased for smaller systems that are willing to be a SOLTRAIN demonstration system (up to 50% of costs may be subsidised).

As the market is currently relatively underdeveloped, the solar thermal industry has relatively high and significantly varying costs for solar thermal systems compared with other countries. However, as the industry gains experience, cost reductions are likely to take place as the industry becomes more familiar with the technology and moves along the learning curve and drives down costs. To facilitate this movement along the learning curve, installers are encouraged to make use of the support from initiatives such as SOLTRAIN which aims to expand the pool of trained people in Southern Africa to support the development of the industry.⁶⁸

⁶⁷ As solar thermal optimised for specific temperature level changing heating needs changes the efficiency. Solar PV in contrast simply continues to generate electricity regardless of what it is used for.

⁶⁸ SOLTRAIN has already provided 24 train the trainer and 39 dissemination courses in Phase 2 (2012–2016) with aim to train 500 persons in 22 training courses in the current Phase 3 (2016–2019) (SOLTRAIN, 2016).

Key conclusions for policymakers

Policymakers' support for the agri-processing and textile industries is evident in the dti's Industrial Policy Action Plan and the DRD&LR /DAFF Agri-parks initiative. Support of the solar thermal industries through the Section 12 income tax rebates as part of increasing energy efficiency and renewable energy uptake in South Africa. Thus the increased uptake of solar thermal in agri-processing is clearly aligned with government policy. The Agri-parks proposal presents a unique opportunity to address both the development of agri-processing and uptake of renewable energy simultaneously, if well structured.

The development of the local solar thermal industry is being hampered by the policy of systems testing, rather than component testing for certification. As only whole systems are locally certified by the SABS, the local manufacturing industry does not have the option of focussing on specific components of a solar thermal system. This limits the competition in the market and ultimately its development and ability to create employment opportunities, especially in the manufacturing industry. It also limits the flexibility of solar thermal systems as changing a component would require a new 'system' to be certified adding significantly to costs for companies. It is clear that that the policy of systems testing needs to be reconsidered.

As the solar industry is currently an 'infant industry' in South Africa, support is required to enable viable businesses that are able to grow and make a sizeable contribution to economic growth and job creation. While the Section 12 income tax rebates have been implemented to allow this, some reconsideration of how the monitoring and verification is done could enable uptake for smaller businesses. This would enable smaller solar thermal projects to benefit from these incentives which are more likely to be undertaken by smaller businesses and thus help the solar thermal industry to develop. As there are a wide range of supporting programmes⁶⁹ working in this space, it is also key to ensure that these different programmes support and leverage off each other and avoid duplication, by encouraging and creating opportunities for communication, collaboration and complementarity.

⁶⁹ For example: South African National Energy Development Institute (SANEDI), Southern Africa Solar Thermal and Electricity Association (SASTELA), Southern African Solar Thermal Training and Demonstration Initiative (SOLTRAIN), Centre for Renewable and Sustainable Energy Studies (CRSES), Sustainable Energy Society of Southern Africa (SESSA), Western Cape Energy Game Changer etc.

REFERENCES

- AEE Intec, 2009. *Thermal use of Solar Energy, Southern African Solar Thermal Training and Demonstration Initiative*. Stellenbosch, AEE Institute for Sustainable Technologies.
- AEE Intec, 2016. *Database for applications of solar heat integration in industrial processes*. [Online] Available at: <http://ship-plants.info/> [Accessed 11 January 2016].
- AAE Intec, 2016. *Matrix of Industrial Process Indicators*. Available at: <http://wiki.zero-emissions.at> [Accessed 15 October 2016].
- Agence Française de Développement, 2015. *Case Studies From the AFD Green Credit Line for South Africa*. [Online] Available at: http://www.sanedi.org.za/wp-content/uploads/2016/09/AFD%20CASE%20STUDIES_v01.pdf [Accessed 24 January 2017].
- Business Day, 2015. *Clothing and textile industry shakes off cobwebs*. [Online] Available at: <http://www.bdlive.co.za/business/trade/2015/12/18/clothing-and-textile-industry-shakes-off-cobwebs> [Accessed 15 August 2016].
- de Klerk, A., 2015. IDM Strategy Review 2015–2018: Life after Rebates. *SAFMA 2015 Annual Conference*.
- Department of Energy, 2013. *2012-Dissaggregated-Balance*. [Online] Available at: http://www.energy.gov.za/files/media/explained/Disaggregated_balance/2012-Dissaggregated-Balance.xlsx [Accessed 4 July 2016].
- Department of Energy, 2015. *solar water heating*. [Online] Available at: <http://www.gov.za/solar-water-heater-programme-update> [Accessed 6 January 2016].
- Department of Rural Development and Land Reform, 2015. *Agri-parks*. [Online] Available at: www.ruraldevelopment.gov.za/agri-parks [Accessed Sept 2016].
- Department of Trade and Industry, 2016. *Industrial Policy Action Plan: IPAP 2016/17 – 2018/19*, Pretoria: dti.
- E3 Energy, 2016. *E3 Energy – CBC Solar Thermal Project*. [Online] Available at: <https://www.youtube.com/watch?v=JXANpox482k> [Accessed 5 July 2016].
- E3 Energy, 2016. *E3 Energy – CBC Solar Thermal Project*. [Online] Available at: <https://www.youtube.com/watch?v=JXANpox482k&t=6s> [Accessed 6 February 2017].
- Energy Research Centre, 2014. *SATIM Methodology v3.2*. [Online] Available at: <http://www.erc.uct.ac.za/Research/esystems-group-satim.htm> [Accessed 19 August 2016].
- Epp, B., 2015. *South Africa: Roadmap Sets 21 GWth target for 2030*. [Online] Available at: <http://www.solarthermalworld.org/content/south-africa-roadmap-sets-21-gwth-target-2030> [Accessed 8 January 2016].
- Eskom, 2016. *Historical average price increase*. [Online] Available at: http://www.eskom.co.za/CustomerCare/TariffsAndCharges/Documents/Historical%20average%20prices%20and%20increase_v20160707.xlsx [Accessed 16 August 2016].
- GreenFoods, 2014. *Solar integration scheme*. [Online] Available at: http://wiki.zero-emissions.at/index.php?title=Solar_integration_scheme [Accessed 17 February 2016].
- Green, J., 2015. *South African Government solar water heating outlook for 2016 – is the DOE'S Latest Initiative Reason for Optimism or Further Exasperation?*. [Online] Available at: <http://sessa.org.za/about-sessa/chairman-s-blog/740-solar-water-heating-outlook-2016> [Accessed 20 January 2016].
- Hassine, I. B. et al., 2015. In: B. Muster, ed. *Solar Process Heat for Production and Advanced Applications: Integration Guideline*. Online: http://task49.iea-shc.org/Data/Sites/7/150218_iea-task-49_d_b2_integration_guideline-final.pdf; IEA SHC Task 49.
- Heimann, C., 2016. *Agri-parks Consultative Workshop*. [Online] Available at http://www.drdir.gov.za/images/2016/18_19November_Agriparks_Consultative_Workshop.pdf [Accessed 7 May 2017].
- Helmke, A. & Hess, S., 2015. Classification of solar process heat system concepts. In: B. Muster, ed. *Integration Guideline. Guideline for solar planners, energy consultants and process engineers. IEA SHC Task 49*. s.l.:s.n., pp. 61–76.
- Hertzog, H., 2012. *A Technical Motivation for: Component Testing for Solar Water Heating*. [Online] Available at: <http://greencape.co.za/assets/Uploads/energy-efficiency/Component-testing-for-SWH-120912-1.pdf> [Accessed 8 February 2016].

APPENDICES

APPENDIX 1

INTERNATIONAL SOLAR HEAT FOR INDUSTRIAL PROCESSES (SHIP) DATABASE

IEA's Task 49: Solar Heat Integration in Industrial processes' database of the solar thermal systems providing industrial process heat is shown in Table A1. The food and beverages industry is shown to be significant with 31% and 12% respectively (or 53 and 20) of a total of 171 installations. The textile industry features less clearly with 5% (8 installations)

Table A1: Solar heating in industrial processes projects internationally by industrial sector

Industrial sector	Count	Share
A Agriculture Forestry and fishing	9	5%
B Mining & Quarrying	7	4%
B Mining & Quarrying	7	4%
C10 Manufacture of Food Products	53	31%
C11 Manufacture of Beverages	20	12%
C12 Manufacture of Tobacco Products	1	1%
C13 Manufacture of textiles	8	5%
C14 Manufacture of wearing apparel	2	1%
C15 Manufacture of leather and related products	8	5%
C16 Manufacture of wood and products of wood and cork, except furniture; manufacture of articles of straw and plaiting materials	1	1%
C20 Manufacture of chemicals and chemical products	4	2%
C21 Manufacture of basic pharmaceuticals and pharmaceutical preparations	1	1%
C22 Manufacture of rubber & plastic products	1	1%
C23 Manufacture of other non-metallic mineral products	2	1%
C24 Manufacture of basic metals	6	4%
C25 Manufacture of fabricated metal products, except machinery and equipment	7	4%
C26 Manufacture of computer, electronic & optical products	1	1%
C28 Manufacture of machinery and equipment n.e.c.	4	2%

Holm, D., 2015. Lessons Learned From SOLTRAIN, South Africa's One Million Solar Water Heaters Initiative and From International Champions – How to Improve Market Penetration in South Africa. In: J. Gibberd & D. Conradie, eds. *Smart and Sustainable Built Environments (SASBE) 2015 Conference Proceedings*, 9 – 11 December 2015. Pretoria: University of Pretoria, p. 443.

Horta, P., 2015. *Process Heat Collectors: State of the Art and available medium temperature collectors*. , SolarPaces Annex IV: IEA SHC Task 49.

IEA SHC, 2015. *Country Report – South Africa: Status of Solar Heating/Cooling and Solar Buildings*. [Online] Available at: <http://www.iea-shc.org/country-report-south-africa> [Accessed 7 January 2016].

IEA, 2013. *Solar and Heat Pump Systems*. [Online] Available at: <http://task44.iea-shc.org/> [Accessed 19 September 2016].

IEA, 2016. *South Africa balances for 2013*. [Online] Available at: <https://www.iea.org/statistics/statisticssearch/report/?country=SOUTHAFRIC&product=balances&year=2013> [Accessed 11 January 2016].

Industrial Development Corporation, 2016. *Clothing and Textiles Competitiveness Programme (CTCP)*. [Online] Available at: <http://www.idc.co.za/clothing-and-textiles-new.html> [Accessed 30 January 2017].

Joubert, E., Hess, S. & Niekerk, J. V., 2016. Large-scale solar water heating in South Africa: Status, barriers and recommendations. *Renewable Energy*, Issue 97, pp. 809–822.

Lampreia, J., 2014. *Industrial renewable heat*. [Online] Available at: <https://www.carbontrust.com/news/2014/05/industrial-renewable-heat/> [Accessed 3 February 2016].

Mauthner, F., Weiss, W. & Spörk-Dür, M., 2015. *Solar Heat Worldwide: Markets and Contribution to the Energy Supply 2013*. [Online] Available at: www.iea-shc.org/data/sites/1/.../Solar-Heat-Worldwide-2015.pdf [Accessed 6 January 2016].

Mauthner, F., Weiss, W. & Spörk-Dür, M., 2016. *Solar Heat Worldwide: Markets and Contribution to the Energy Supply 2014*. [Online] Available at: http://www.ren21.net/wp-content/uploads/2016/06/GSR_2016_Full_Report_REN21.pdf [Accessed 4 July 2016].

Pancho Ndebele, 2015. *Technology Innovations: Solar Grid-based (CSP)*. [Online] Available at: http://sastela.org/wp-content/uploads/2015/10/Issue-Paper_Technology-Innovations_CSP_21.07.20151.pdf [Accessed 22 February 2016].

Solar GIS, 2016. *Free download of solar resource maps*. [Online] Available at: <http://solargis.com/products/maps-and-gis-data/free/overview/> [Accessed 25 October 2016].

SOLTRAIN, 2015. *Solar Thermal Demonstration Systems in Southern Africa: Applications, facts, cost, solar yields environmental effects*. Gauteng: AEE Intec.

SOLTRAIN, 2015. *The South African Solar Thermal Technology Road Map (SA-STTRM): Direction for South Africa's solar thermal energy future A discussion document*. [Online] Available at: http://www.soltrain.co.za/wp-content/uploads/2016/02/Solar-Thermal-Roadmap_South-Africa.pdf [Accessed 23 February 2016].

SOLTRAIN, 2015. *Welcome the Sun: Western Cape Flagship District*. Stellenbosch: SOLTRAIN2.

SOLTRAIN, 2016. *South Africa: Cape Brewing Company's solar process heat system*. [Online] Available at: <http://www.soltrain.co.za/soltrain-news/60-cape-brewing-company-s-solar-process-heat-system> [Accessed 6 February 2017].

SOLTRAIN, 2016. *Specialised Course for professionals on Solar Heat for Industrial Applications*. Stellenbosch, November 2016.

SOLTRAIN, n.d. *SOLTRAIN Phase II: Completed*. [Online] Available at: <http://soltrain.co.za/about-soltrain/soltrain-phase-ii> [Accessed 6 February 2017].

Statistics South Africa, 2012. *Standard Industrial Classification of all Economic Activities (SIC) Seventh Edition*. 7th ed. Pretoria: Statistics South Africa.

StatsSA, 2016. *CPIHistory*. [Online] Available at: <http://www.statssa.gov.za/publications/P0141/CPIHistory.pdf?> [Accessed 16 August 2016].

Tshehla, M., 2016. *Utility-scale renewable energy sector – 2016 Market Intelligence Report*, Cape Town: GreenCape.

Western Cape Government, 2016. *Energy Security Game Changer*. [Online] Available at: <https://www.westerncape.gov.za/110green/energy-security-game-changer> [Accessed 17 August 2016].

Witi, J. & Stevens, L., 2013. *GHG Inventory for South Africa: 2000-2010*, s.l.: Department Environmental Affairs.

APPENDIX 2

ALTERNATIVE PRESENTATION OF HEATING INTEGRATION CONCEPTS

Industrial sector	Count	Share
C29 Manufacture of motor vehicles, trailers and semi-trailers	4	2%
C30 Manufacture of other transport equipment	1	1%
C31 Manufacture of furniture	1	1%
C33 Repair and installation of machinery & equipment	1	1%
D Electricity, gas, steam and air-conditioning supply	2	1%
E Water supply; sewerage; waste management and remediation activities	3	2%
F Construction	2	1%
H Transporting & storage	3	2%
J Information and communication	1	1%
M Professional, scientific and technical activities	1	1%
S Other services and activities	10	6%
Total	171	100%

SOURCE: OWN CALCULATIONS BASED ON DATA AVAILABLE AT: [HTTP://SHIP-PLANTS.INFO/](http://SHIP-PLANTS.INFO/) (AEE INTEC, 2016)

Table A2 provides a breakdown of the different solar heating integration concepts as an alternative to representation in Figure 9.

Table A2: Summary of solar heat integration concepts

Level of integration	Heat transfer medium	Conventional way of heating	Solar heat integration concept	
Supply level	Steam		Parallel integration (direct or indirect)	
			Heating of feed water	
			Heating of make-up water	
	Liquid		Parallel integration (direct or indirect)	
			Return flow boost	
			Solar heating of storages or cascades	
Process level		External heat exchanger	Heating of process medium	
			Heating of intermediate hot water circuit	
			Heating of bath, machinery or tank	
			Heating of input streams	
		Internal heat exchanger		
	Steam supply		Vacuum steam	
			Low pressure steam	

SOURCE: GREENFOODS EFFICIENCY FINDER (GREENFOODS, 2014)

APPENDIX 3

SOUTH AFRICAN SOLAR THERMAL TECHNOLOGY ROADMAP

The full breakdown of the SA-STTRM growth to achieve the vision of 0.5 m² per capita by 2030 is shown in Figure 23. This displays a breakdown into the different components of the solar thermal market, of which larger systems (industrial / commercial / multifamily installations) is one as presented in Figure 13. The full breakdown suggests that the residential heating market is the largest market for solar thermal uptake.

Figure 23: Envisioned accumulated installations in m² 2014–2030

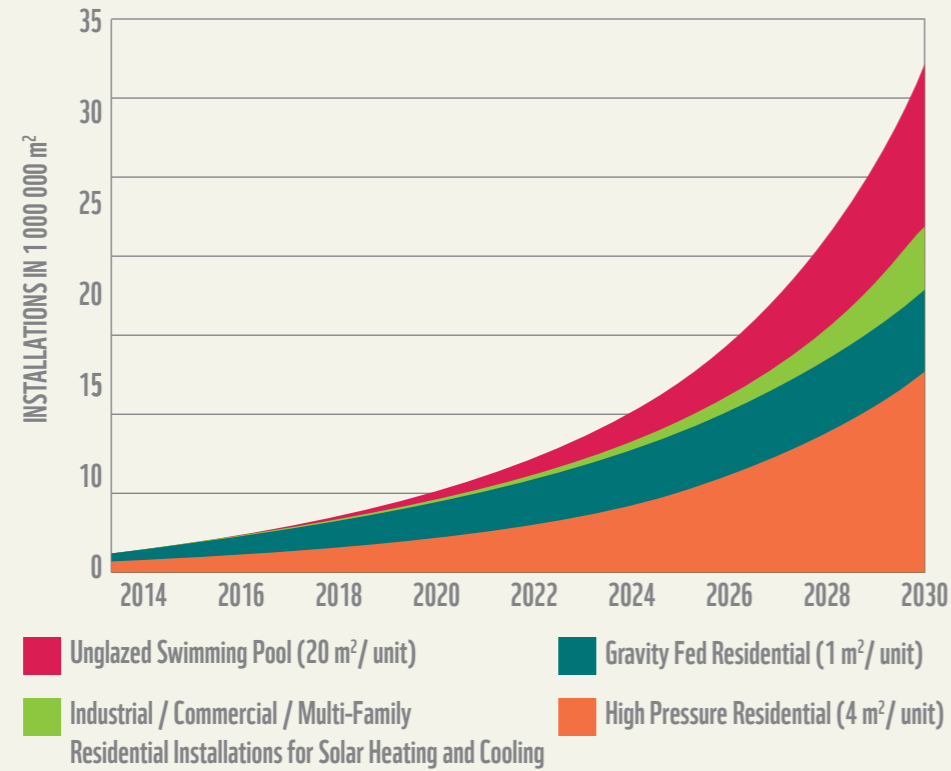

SOURCE: SOLTRAIN: SA SOLAR THERMAL TECHNOLOGY ROAD⁷⁰

70 Available at http://www.soltrain.org.za/assets/library/51_SOLTRAIN.pdf, p. 32.

APPENDIX 4

AGRI-PROCESSING PROCESSES HEAT NEEDS OVERVIEW

Table A3: Matrix of industrial process indicators, food and beverages industry efficiency Finder

		Milk products	Fruits / vegetables / herbs	Sugar	Beer	Fats / oils	Chocolate / cacao / coffee	Starch / potatoes / grain mill products	Bread / biscuits / cakes	Wine / beverage	Meat	Fish	Aroma	Baby food	Solar integration	Emerging technologies process intensification	Heat integration
Unit operation	Typical processes	√	√	√	√	√	√	√	√	√	√	√	√	√	√	√	√
Cleaning	Cleaning of bottles & cases	√	√		√	√			√	√	√	√			√	√	
	Washing products	√	√					√	√	√	√				√	√	√
	Cleaning of production halls and equipment	√	√				√	√	√	√	√				√	√	√
Drying	Drying	√	√				√	√	√	√	√	√		√	√	√	√
Evaporation & distillation	Evaporation	√	√	√	√	√	√								√		√
	Distillation				√	√							√		√	√	√
	Deodorisation					√	√								√	√	
Blanching	Blanching		√				√			√					√	√	√
Pasteurisation	Pasteurisation	√	√		√			√	√						√	√	√*
Sterilisation	Sterilisation	√	√						√						√	√	√
Cooking	Cooking & boiling		√		√		√	√	√		√	√			√	√	√
Other process heating	Preheating & process water	√	√		√				√								√
	Soaking		√		√		√				√						
	Thawing	√									√	√				√	
	Peeling	√	√								√					√	√

APPENDIX 5 TEXTILE INDUSTRIAL SECTORS

Table A4: Matrix of Industrial Process Indicators, Textile Industry Efficiency Finder

		Milk products	Fruits / vegetables / herbs	Sugar	Beer	Fats / oils	Chocolate / cacao / coffee	Starch / potatoes / grain mill products	Bread / biscuits / cakes	Wine / beverage	Meat	Fish	Aroma	Baby food	Solar integration	Emerging technologies process intensification	Heat integration
General process heating	Boiler feed-water preheating	√	√	√	√	√	√	√	√	√	√	√	√	√	√		√
Heating of production halls	Heating of production halls	√	√	√	√	√	√	√	√	√	√	√	√	√	√		√
Cooling of production halls	Cooling of production halls	√	√	√	√	√	√	√	√	√	√	√	√	√	√		√
Cooling processes	Cooling, chilling & cold stabilisation	√	√	√	√	√	√	√	√	√	√	√	√	√	√	√	√
	Ageing	√			√				√	√	√	√			√	√	√
Melting	Melting	√				√											√
Extracting	Extracting		√	√		√	√									√	√
Bleaching	Bleaching		√													√	√
Fermentation	Fermentation	√*			√				√*	√	√	√				√	
Temperature level																	
	20-40 °C	√	√		√		√		√	√							
	40-60 °C	√	√		√		√		√	√	√		√				
	60-80 °C	√	√	√	√	√	√	√	√	√	√	√	√				
	> 80 °C	√	√	√	√	√	√	√	√	√	√	√	√				

SOURCE: AAE INTEC

Table A3 above highlights the wide range of processes requiring low temperature heat across a wide range of food and beverages industrial sectors, making it an ideal industry to consider solar integration. The database also has guidelines for each of the industrial sub-sectors shown above.

Unit Operation	Typical processes	Natural fibres					Chemical fibres		
		Vegetable origin		Animal origin		Fibre blends	Natural polymer		Synthetic polymer
		Cotton and bast fibres	Flax	Wool	Silk		Viscose/ Cupro/ Modal (regenerated)	Acrylic/ Polyamide	Polyester
Cleaning	Scouring	√		√	√	√			
	Cleaning of production halls								
	Washing/rinsing								√
	Desizing								
	Carbonising			√					
	Fulling			√					
Drying	Drying								
Other process heating	Singeing								
	Mercerisation	√				√			
	Sizing								
	Thermofixation							√	√
	Thermobonding & Thermofusion					√			
	Melting resin impregnation					√			
	Finishing	√		√	√	√	√	√	√
General process heating	Boiler feed water preheating								
Heating of production halls	Heating of production halls								
Cooling of production halls	Cooling of production halls								
Bleaching	Bleaching	√	√	√	√		√	√	√
Painting	Dyeing	√	√	√	√	√	√	√	√
	Printing			√	√				

		Natural fibres					Chemical fibres		
		Vegetable origin		Animal origin		Fibre blends	Natural polymer		Synthetic polymer
Unit Operation	Typical processes	Cotton and bast fibres	Flax	Wool	Silk		Viscose/ Cupro/ Modal (regenerated)	Acrylic/ Polyamide	Polyester
Temperature level									
20–40 °C		X			X				
40–60 °C		X		X	X		X	X	X
60–80 °C		X		X	X		X	X	X
80–100 °C		X		X	X		X	X	X
100–120 °C		X		X	X		X	X	X
120–140 °C		X		X	X		X	X	X
140–160 °C									X
≥ 160 °C									X

SOURCE: AAE INTEC

The matrix shows the wide range of processes as well as the lower temperature needs of natural materials, aligning them well with solar heat integration.



The Centre for Renewable and Sustainable Energy Studies (CRSES) at Stellenbosch University (SU) was established in 2007 as the national hub for postgraduate programmes in renewable and sustainable energy (RE) through a grant from the Department of Science and Technology (DST). CRSES has a dual purpose: the training of scientists and engineers with the required technical expertise to unlock the country's RE resources, and the implementation of appropriate technologies for the sustainable use of RE.

CRSES acts as a central point of entry into Stellenbosch University for the general field of RE. The work of CRSES focuses on contract research, postgraduate modules in RE and the coordination of other training courses in RE. Some contract research projects are completed within CRSES while others are channelled to the relevant academic departments or research groups of the University.

<http://www.crses.sun.ac.za>



GreenCape is a non-profit organisation that drives the widespread adoption of economically viable green economy solutions from the Western Cape. Our vision is for South Africa to be the green economic hub of Africa – the regional headquarters and manufacturing centre for leading companies in this space.

GreenCape assists businesses through knowledge, networking and advocacy, to remove barriers to their establishment and growth. We also assist local, provincial and national government to build a resilient green economy, through technical support and knowledge, and access to networks of key players across business, academia, and internationally.

<http://www.greencape.co.za>

WWF

WWF is one of the world's largest and most experienced independent conservation organisations, with over 6 million supporters and a global network active in more than 100 countries.

WWF's mission is to stop the degradation of the planet's natural environment and to build a future in which humans live in harmony with nature, by conserving the world's biological diversity, ensuring that the use of renewable natural resources is sustainable, and promoting the reduction of pollution and wasteful consumption.

WWF South Africa's Policy and Futures Unit undertakes enquiry into the possibility of a new economy that advances a sustainable future. The unit convenes, investigates, demonstrates and articulates for policymakers, industry and other players the importance of lateral and long term systemic thinking. The work of the unit is oriented towards solutions for the future of food, water, power and transport, against the backdrop of climate change, urbanisation and regional dynamics. The overarching aim is to promote and support a managed transition to a resilient future for South Africa's people and environment. The organisation also focuses on natural resources in the areas of marine, freshwater, land, species and agriculture.

www.wwf.org.za

Authors:
Pieter Janse van Vuuren, GreenCape
Lauren Basson, GreenCape
Angelo Buckley, CRSES
Karin Kritzing, CRSES
Ulrich Terblanche, CRSES
Manisha Gulati, WWF-SA
Louise Scholtz, WWF-SA

Special contributors:
The authors would like to thank everyone involved for their collaboration and contributions which helped to improve the final report.

Policy and Futures Unit

www.wwf.org.za
For more information, contact:
Louise Scholtz lscholtz@wwf.org.za

Design:
Farm Design, www.farmdesign.co.za

Cover Photograph:
Stellenbosch University, CRSES

Recommended citation:
WWF, 2017, Industrial scale solar heat in South Africa: Opportunities in agri-processing and textiles. WWF-SA, South Africa.

© Text and graphics: 2017 WWF
All right reserved.

Published in August 2016 by WWF-SA, Cape Town, South Africa.
Any reproduction in full or in part must mention the title and credit WWF-SA as the copyright owner.

50%

of energy use in South Africa is for heat



944 - 4 277 GWh per annum

potential solar heat used in agri-processing and textile industries in South Africa

AGRI-PROCESSING & TEXTILES

both require a significant amount of low temperature heat (below 160 °C)

COST COMPETITIVE

solar thermal shown to be financially feasible substitution for most fossil fuels



Why we are here

To stop the degradation of the planet's natural environment and to build a future in which humans live in harmony with nature.

wwf.org.za/energy